

公園型及び片面歩車道境界ブロック すりつけ型 (斜) 及び切り下げ型 (平)

公園型 1本すりつけ型 (1本斜)

MT-20型

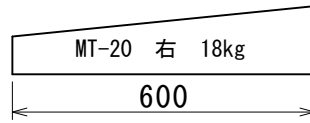
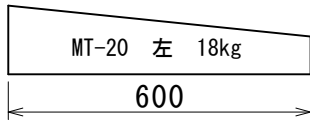
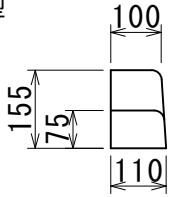

MT-50型

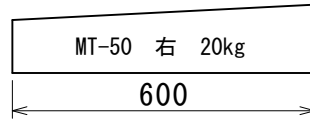
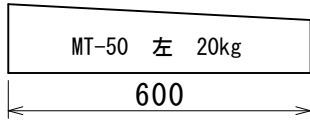
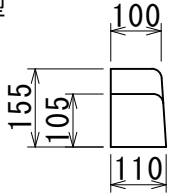

A型 1本すりつけ型 (1本斜)

MT-A20型

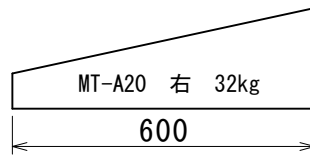
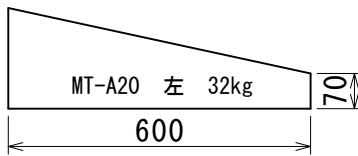
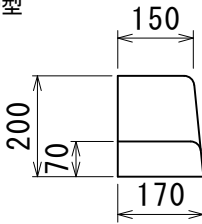

MT-A50型

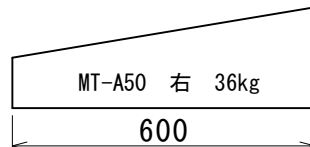
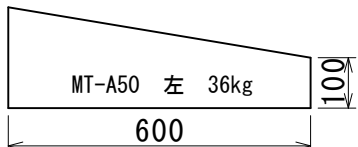
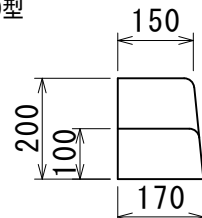

MT-A1型

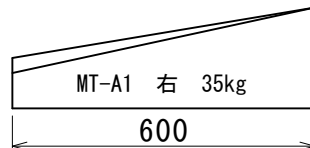
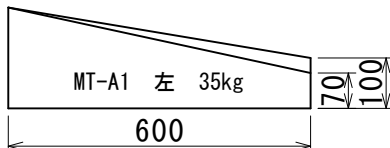
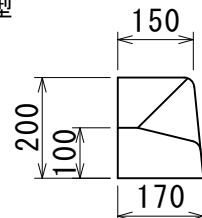

MT-A2型

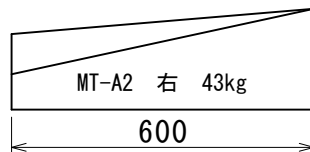
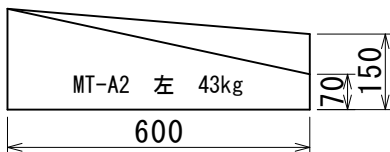
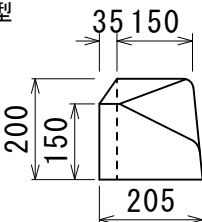

都型(府中市型) A3斜

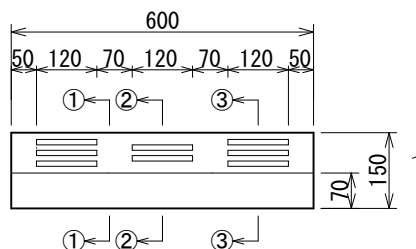
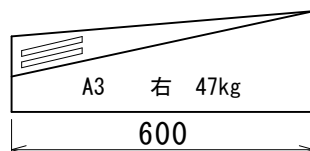
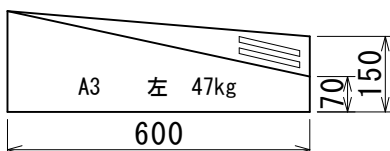
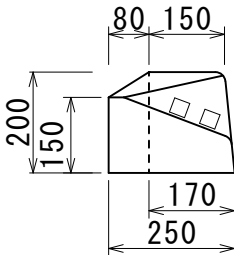

②-②

③-③

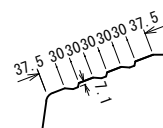
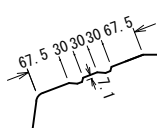

切り下げ型 (平)

MD-20型

12kg

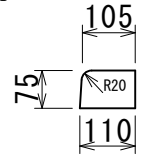

MD-50型

16kg

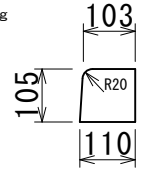

MD-A20型

17kg

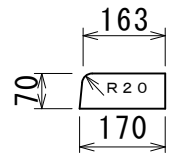

MD-A50型

24kg

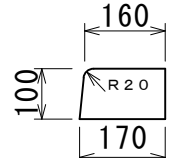

MD-A1型

21kg

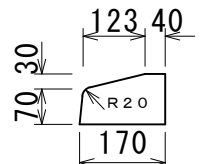

MD-B2型

34kg

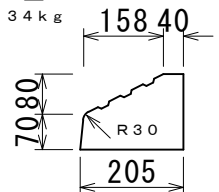

都型(府中市型) B3中

41kg

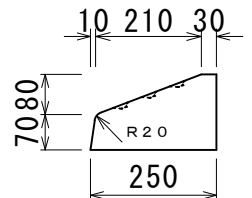

片面歩車道境界ブロック すりつけ型（斜）及び切り下げ型（平）

A型 1本すりつけ型（1本斜）

MT-AF2型

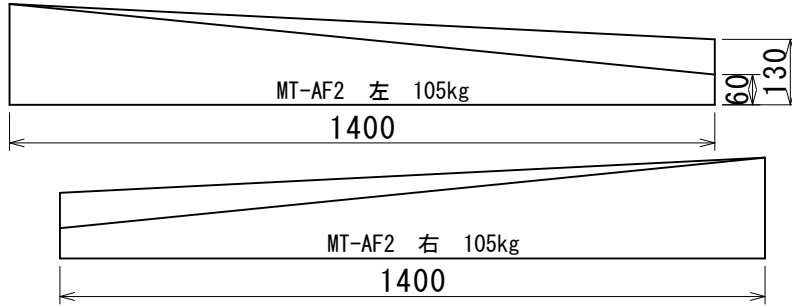
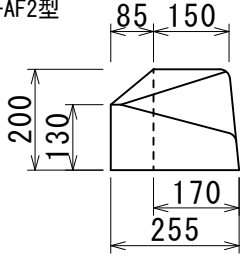

MD-ABF2型 (L=2000)
118kg

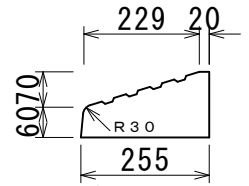

切り下げ型（平）

A型 2本すりつけ型（2本斜）

MT-A21, 22型

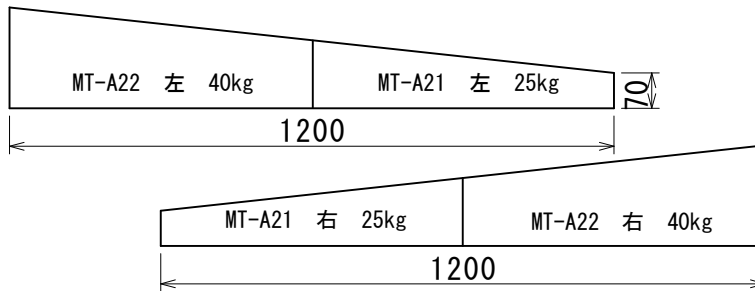
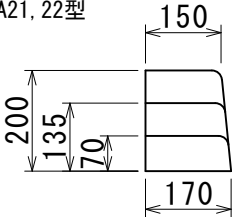

MD-A20型
17kg

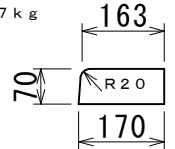

MT-A51, 12型

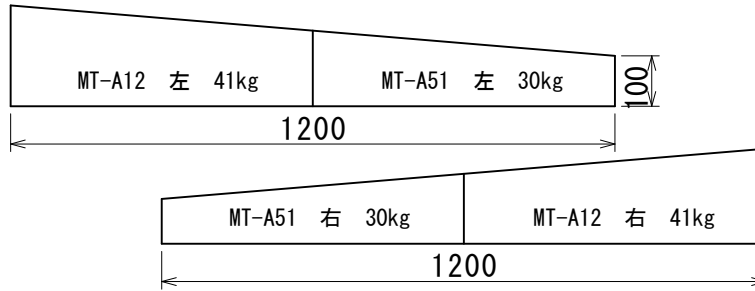
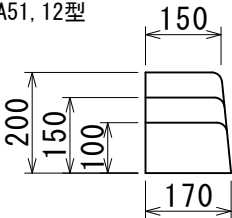

MD-A50型
24kg

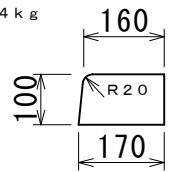

MT-A11, 12型

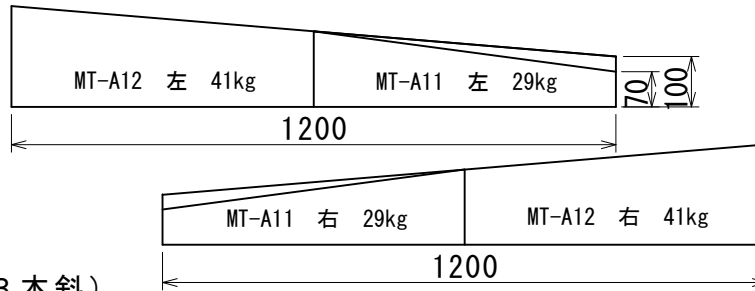
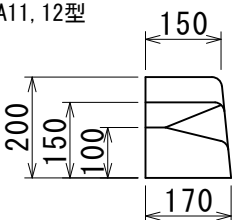

MD-A1型
21kg

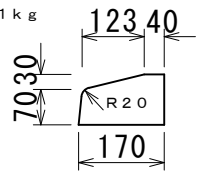

A型 3本すりつけ型（3本斜）

MT-A321, 322, 323型

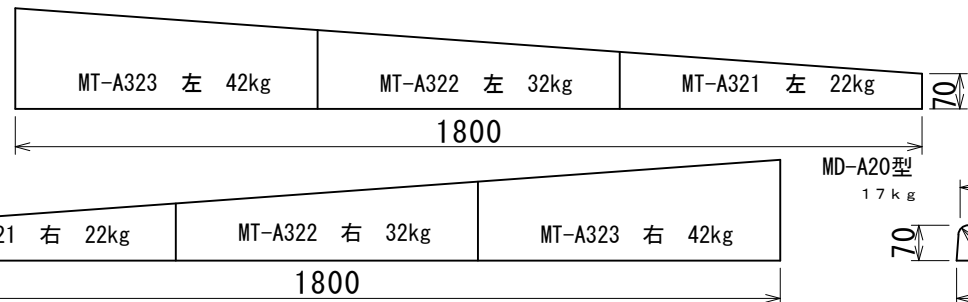
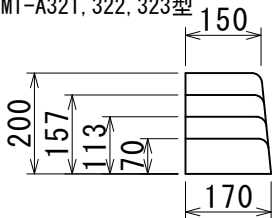

MD-A20型
17kg

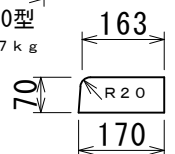

切り下げ型曲線用

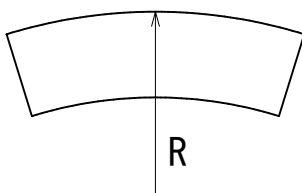

MD-A20

MD-BK0

MD-A1

MD-B20

MD-B50

MD-A50

MD-B1

片面歩車道境界ブロック すりつけ型 (斜) 及び切り下げ型 (平)

B型 1本すりつけ型 (1本斜)

切り下げ型 (平)

MT-BK0型

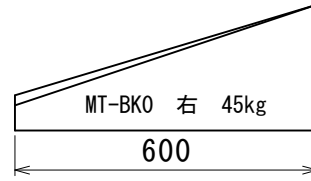
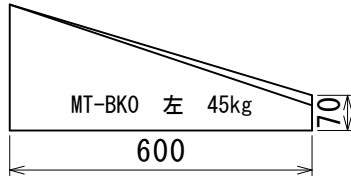
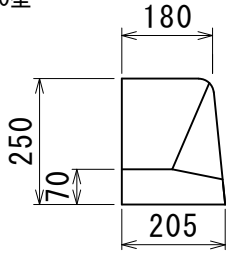

MD-BK0型

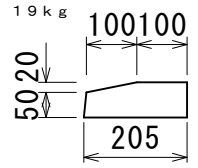

MT-B20型

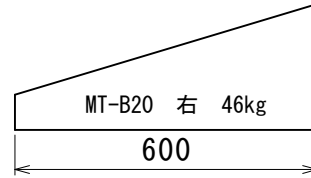
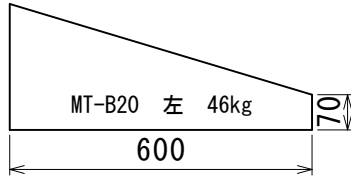
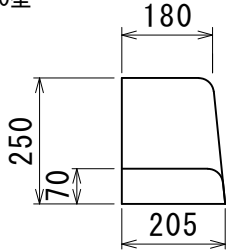

MD-B20型

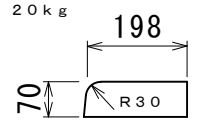

MT-B50型

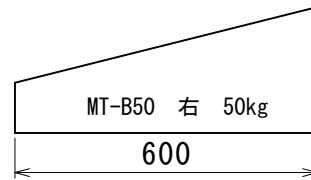
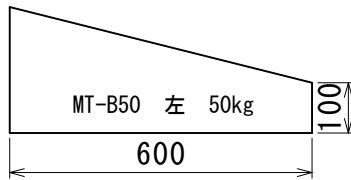
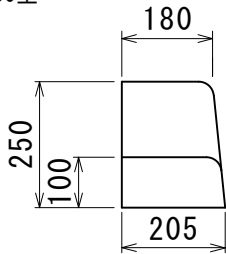

MD-B50型

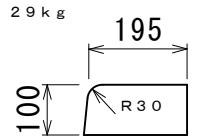

MT-B1型

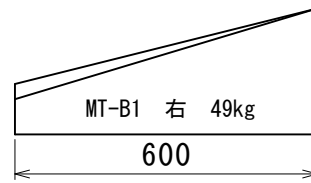
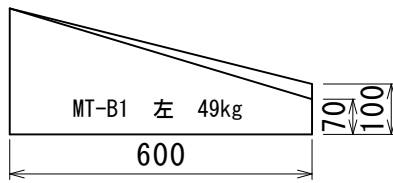
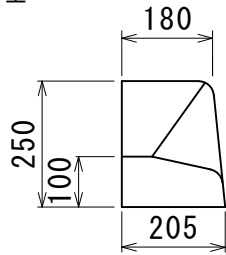

MD-B1型

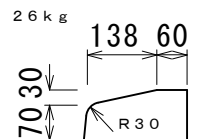

MT-UB2型

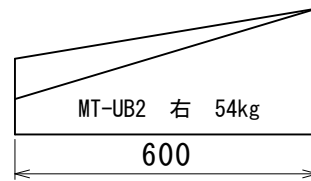
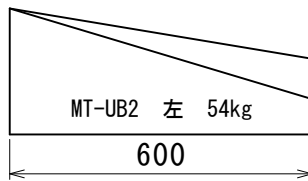
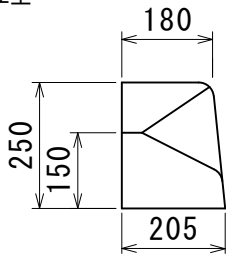

MD-B2型

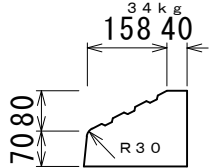

MT-BF2型

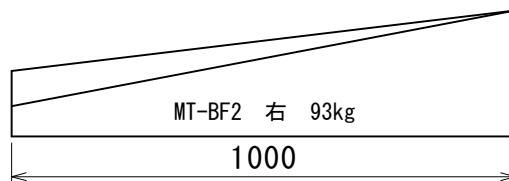
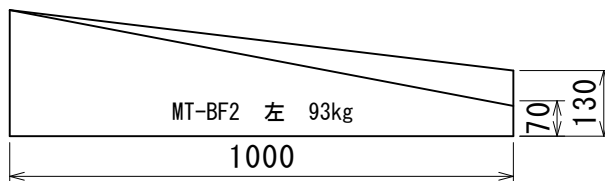
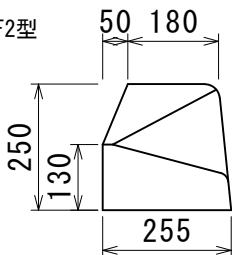

MD-ABF2型 (L=2000)

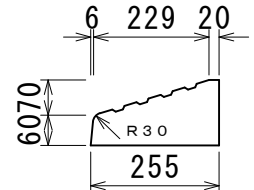

片面歩車道境界ブロック

B型 2本すりつけ型 (2本斜)

切り下げ型 (平)

MT-B2, 13型

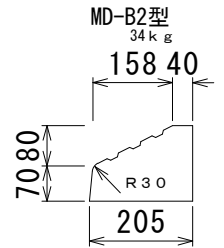
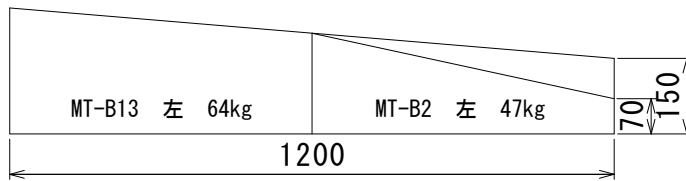
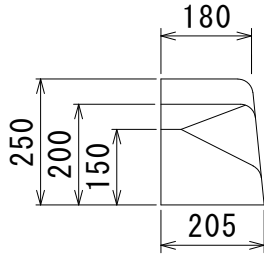

B型 3本すりつけ型 (3本斜)

UDMT-B21, 22, 23型

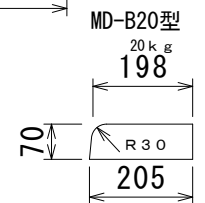
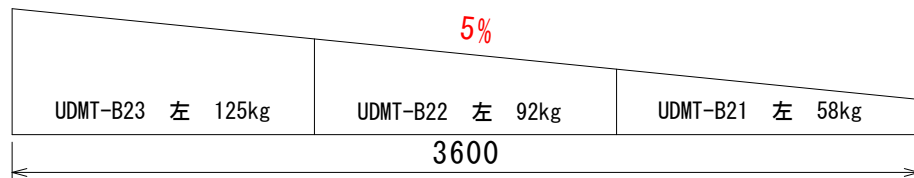
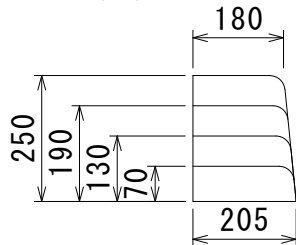

UDMT-B11, 12, 13型

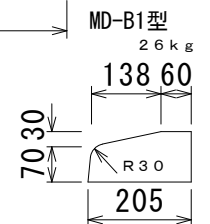
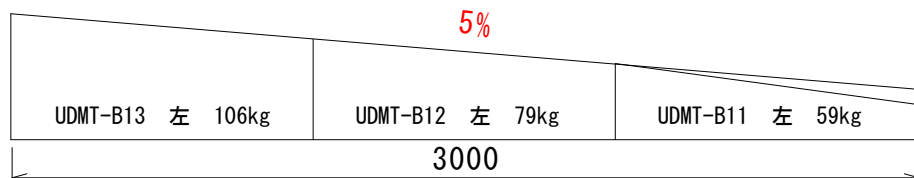
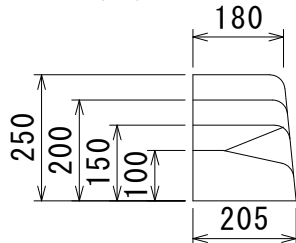

MT-B21, 22, 23型

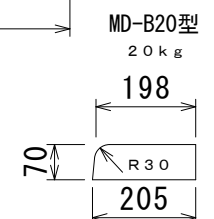
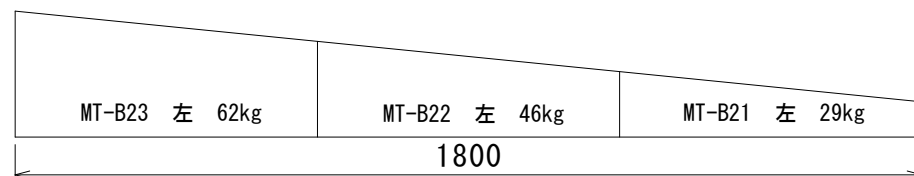
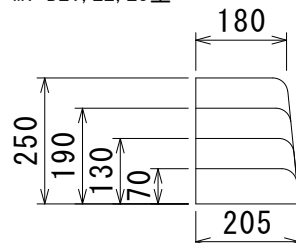

片面歩車道境界ブロック すりつけ型 (斜) 及び切り下げ型 (平)

B型 3本すりつけ型 (3本斜)

切り下げ型 (平)

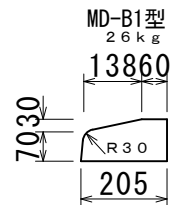
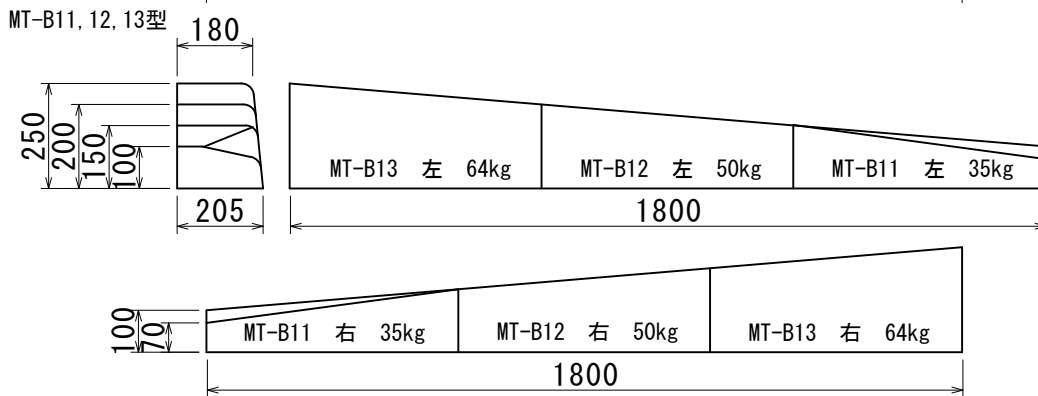
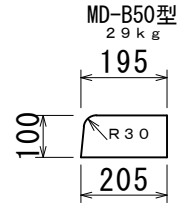
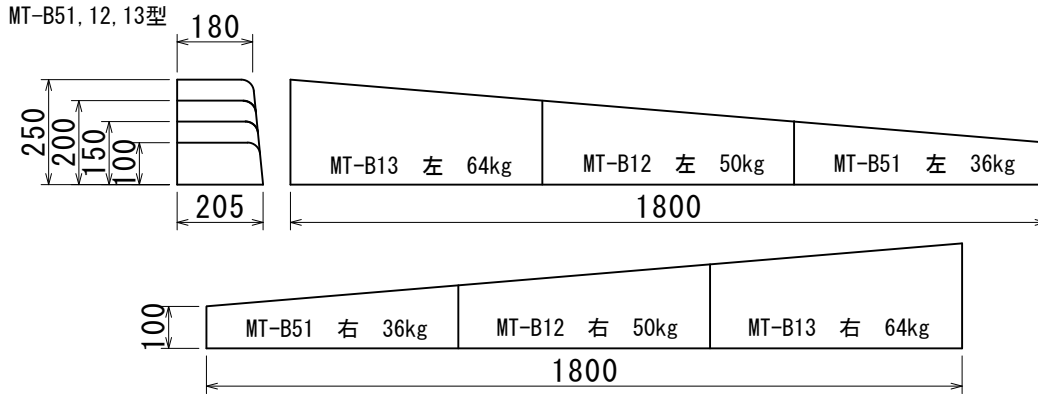

C型 本1本すりつけ型 (1本斜)

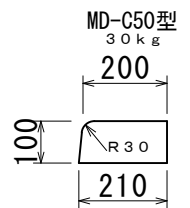
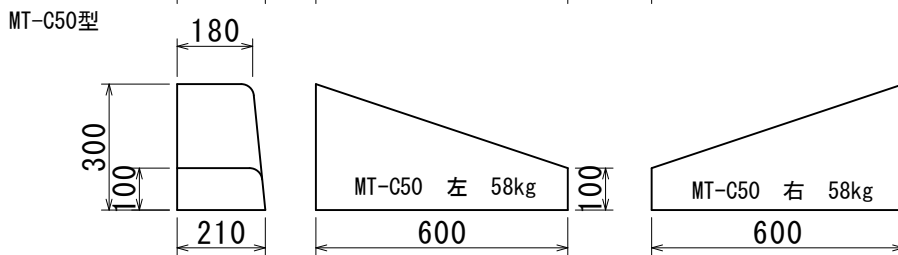
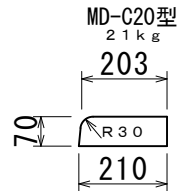
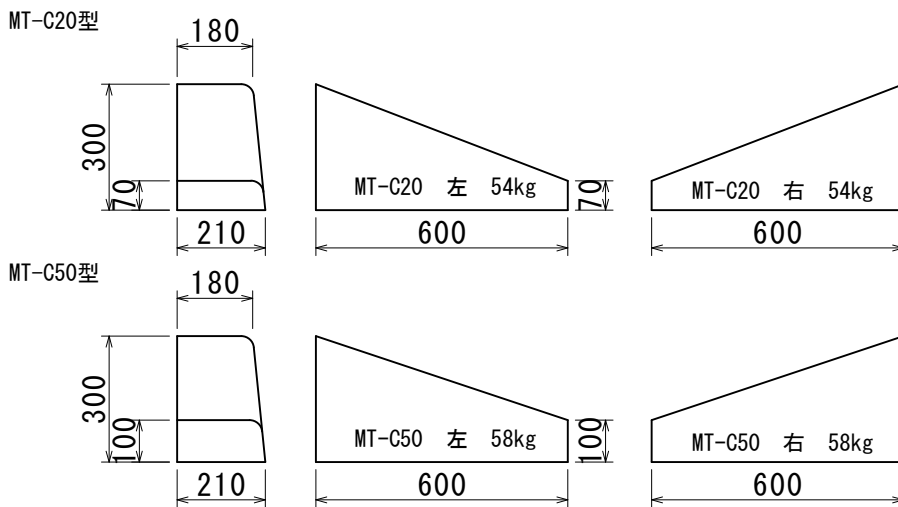

C型 本3本すりつけ型 (3本斜)

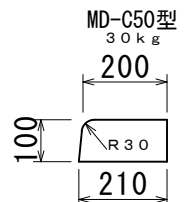
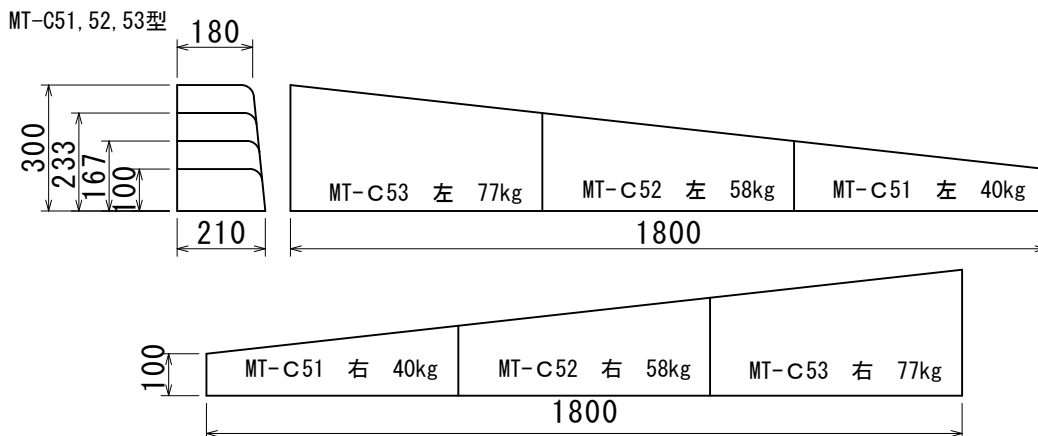

歩車道境界ブロック すりつけ型 (斜) 及び切り下げ型 (平)

A型 1本すりつけ型 (1本斜)

マウントアップ型 MT-AF25型 (32kg)

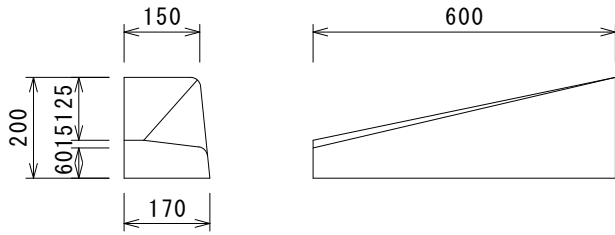

フラット型 FT-AF25型 (31kg)

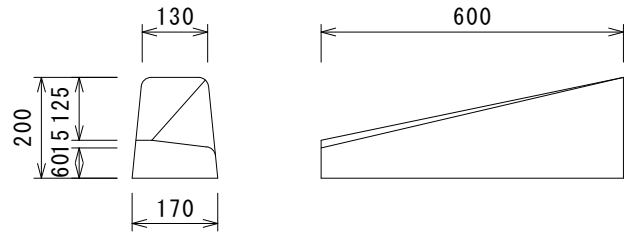

B型 1本すりつけ型 (1本斜)

マウントアップ型 MT-ABF25型 (43kg)

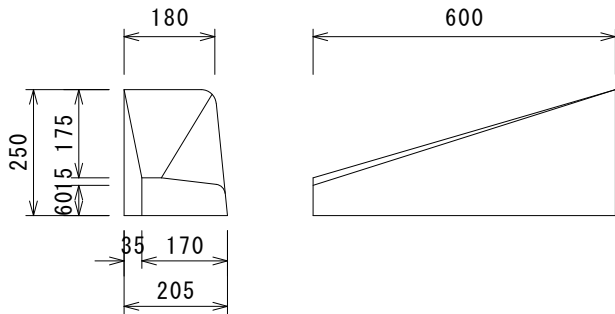

フラット型 FT-ABF25型 (41kg)

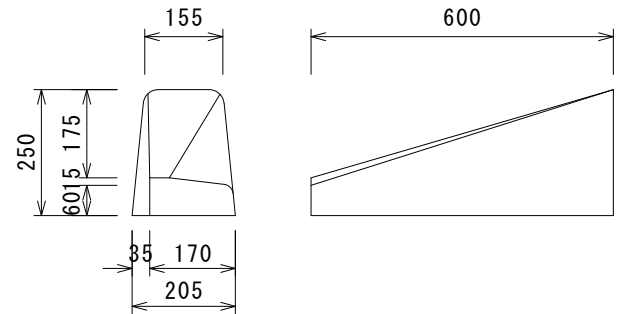

マウントアップ型 MT-BF25型 (46kg)

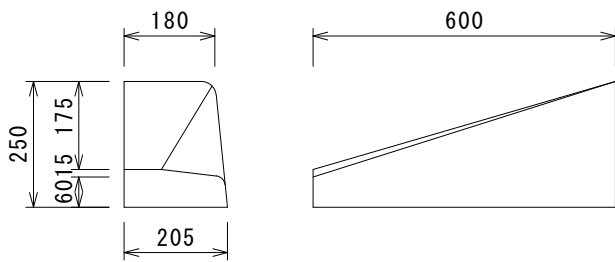

フラット型 FT-BF25型 (44kg)

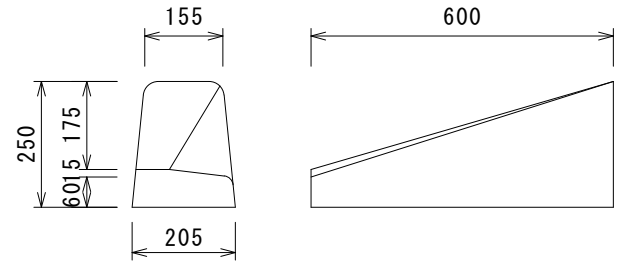

切り下げ型 (ハリアーフリー型)

MD-AF25型 (17kg)

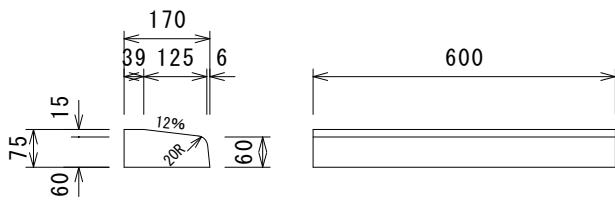

MD-BF25型 (21kg)

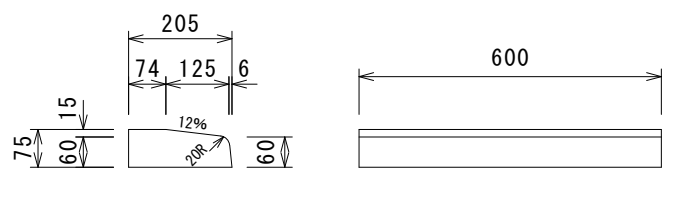

MD-AF25E型 (21kg)

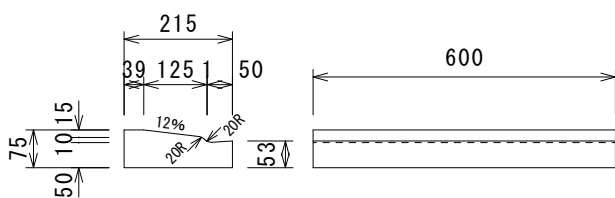

MD-BF25E型 (25kg)

