

国交省 L 形 縁塊・すりつけ型 (斜) 及び切り下げ型 (平)

I 型切り下げ型縁塊 (平)

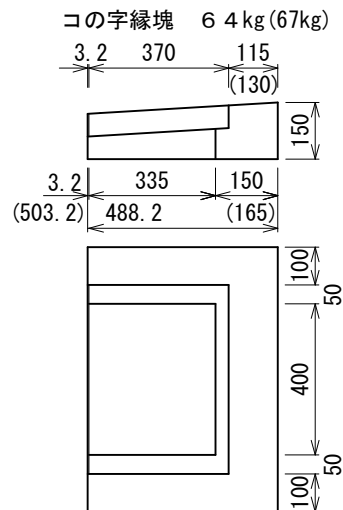
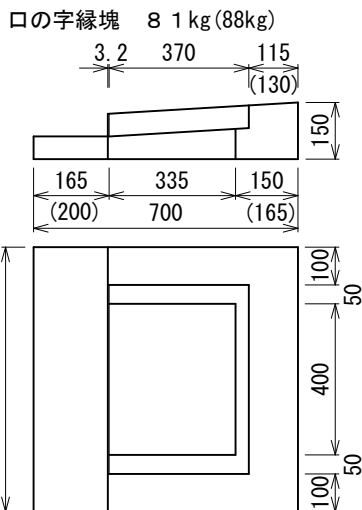
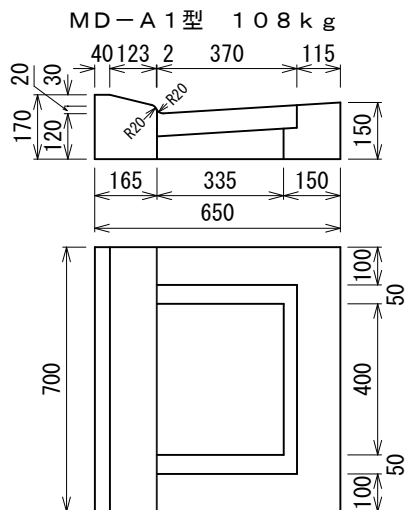

I 型 (II 型) 特殊縁塊

II 型切り下げ型縁塊 (平)

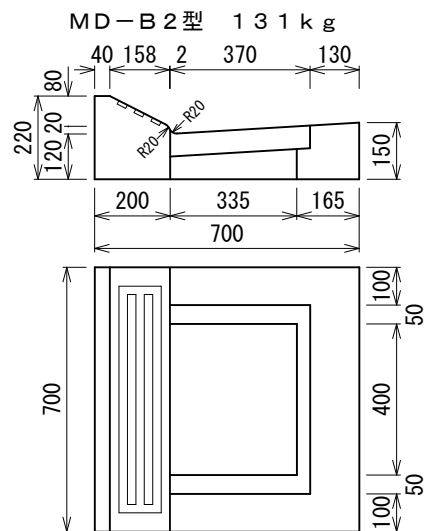
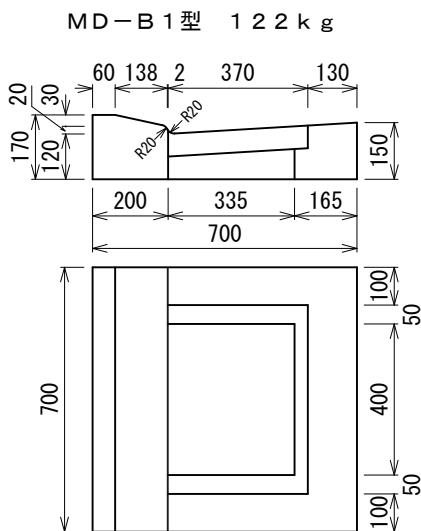
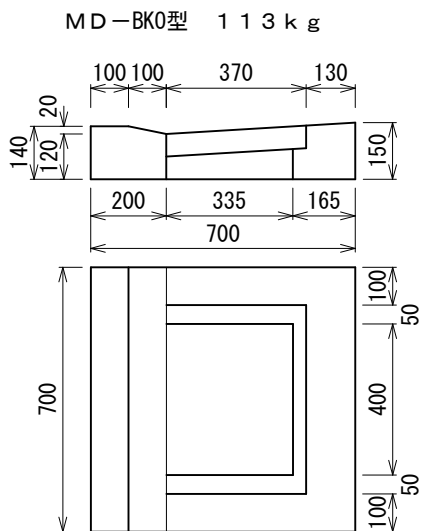

I 型 1 本すりつけ型 (1 本斜)

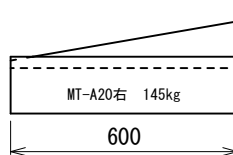
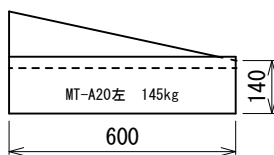
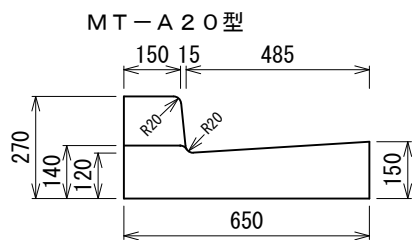

I 型切り下げ型 (平)

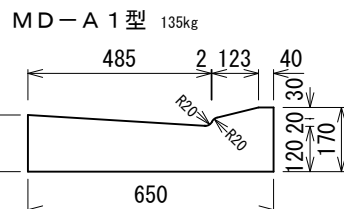
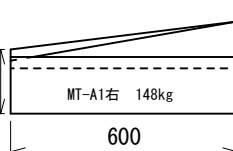
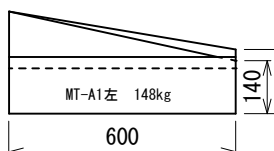
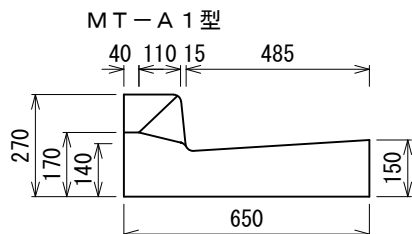
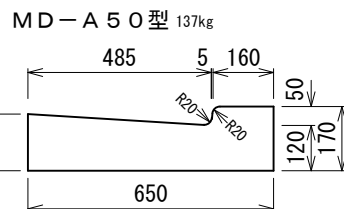
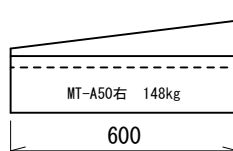
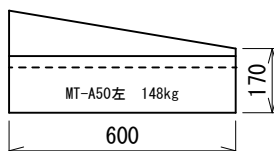
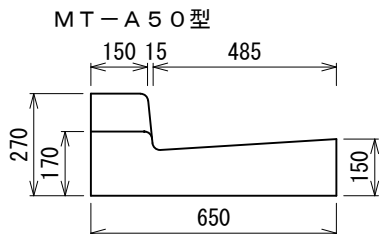
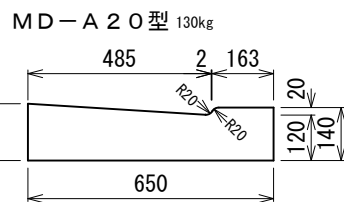

国交省 L 形 すりつけ型 (斜) 及び切り下げ型 (平)

I 型 1 本すりつけ型 (1 本斜)

MT-A 2 型

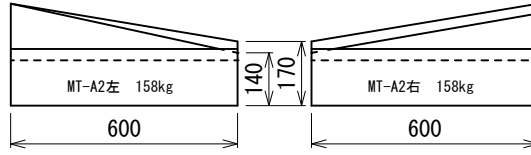
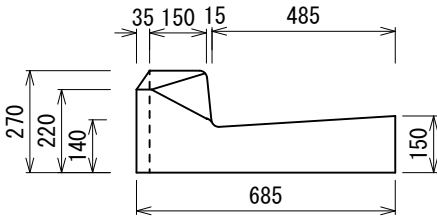

I 型切り下げ型 (平)

MD-A 2 型 151kg

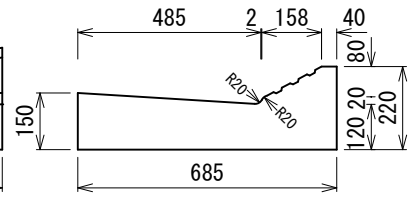

MT-A F 2 型

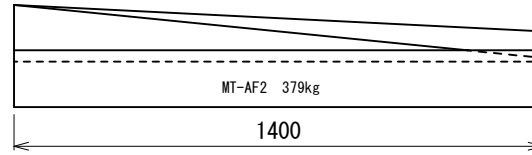
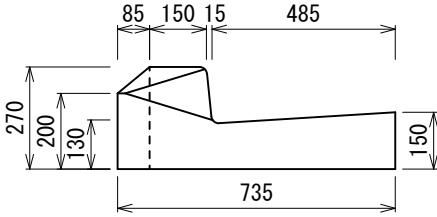

MD-A F 2 型 (L=2000) 525kg

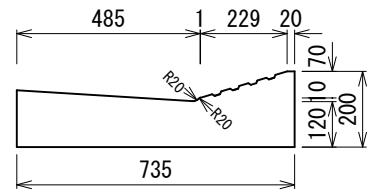

I 型 2 本すりつけ型 (2 本斜)

MT-A 2 1, 2 2 型

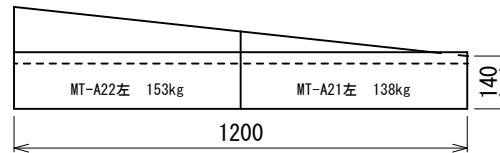
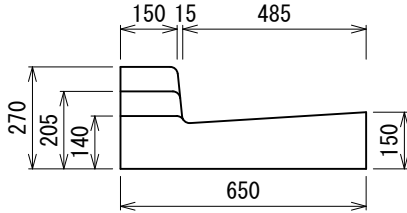

MD-A 2 0 型 130kg

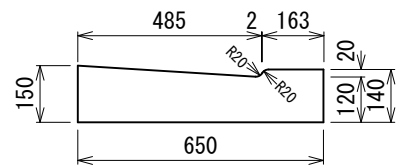

MT-A 5 1, 1 2 型

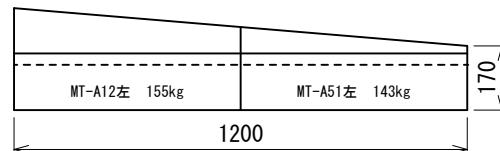
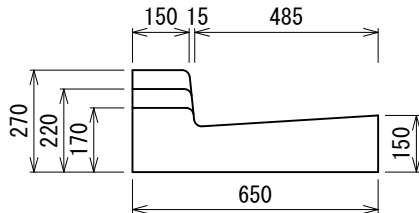

MD-A 5 0 型 137kg

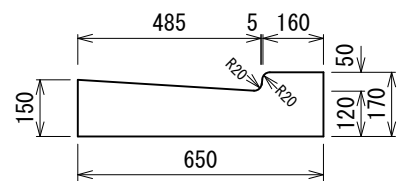

MT-A 1 1, 1 2 型

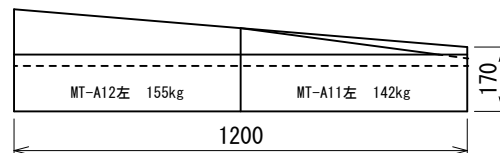
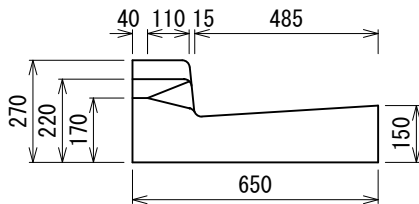

MD-A 1 型 135kg

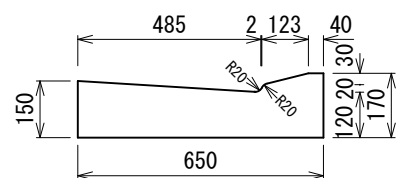

国交省 L 形 すりつけ型 (斜) 及び切り下げ型 (平)

II 型 1 本すりつけ型 (1 本斜)

MT-BK0 型

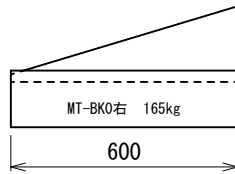
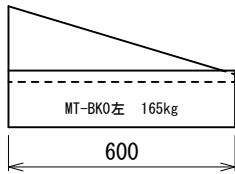
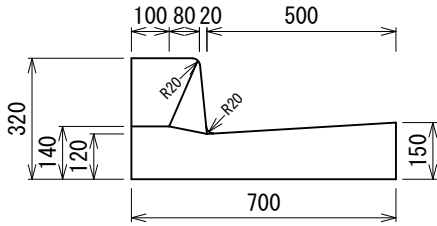

II 型 切り下げ型 (平)

MD-BK0 型 139kg

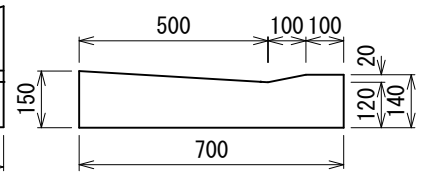

MT-B20 型

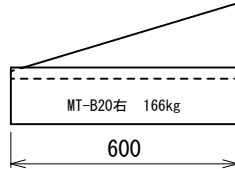
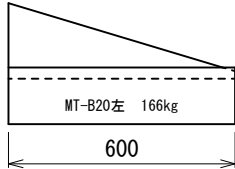
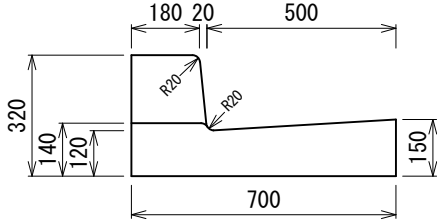

MD-B20 型 140kg

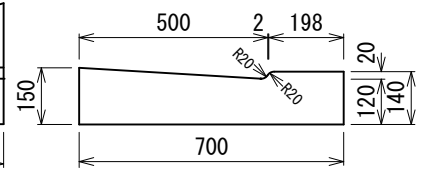

MT-B50 型

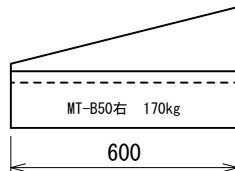
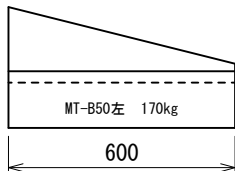
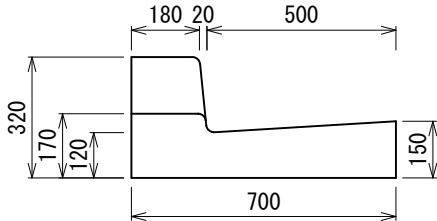

MD-B50 型 149kg

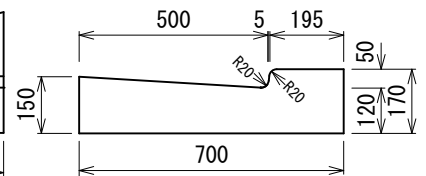

MT-B1 型

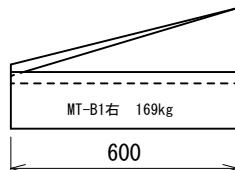
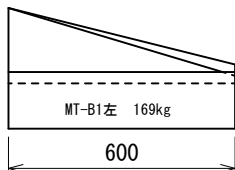
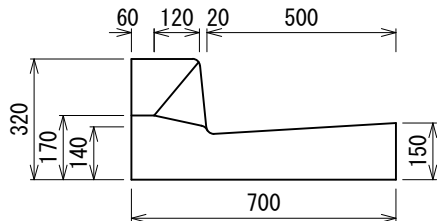

MD-B1 型 146kg

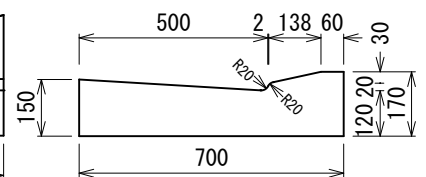

MT-BF2 型

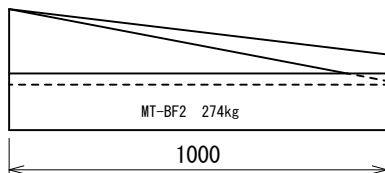
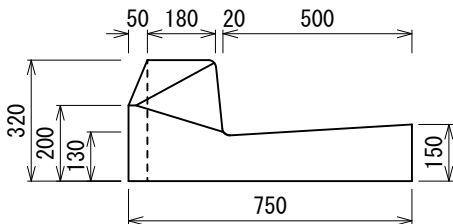

MD-BF2 型 (L=2000) 536kg

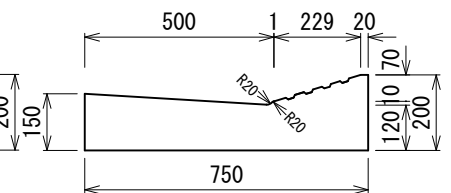

II 型 2 本すりつけ型 (2 本斜)

MT-B2, 13 型

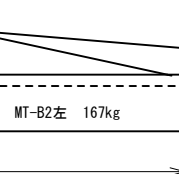
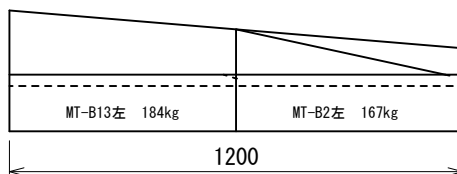
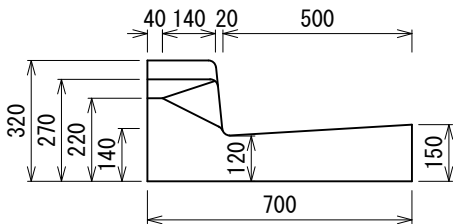

MD-B2 型 154kg

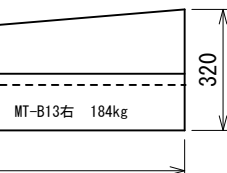
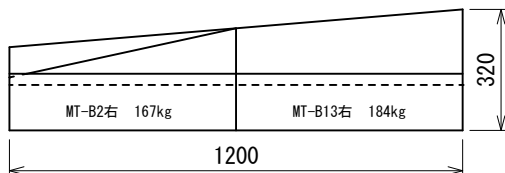
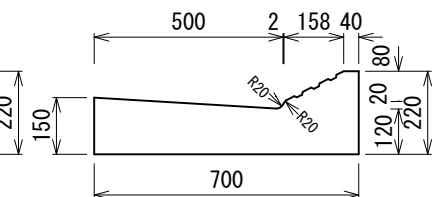

国交省 L 形 すりつけ型 (斜) 及び切り下げ型 (平)

II 型 3 本すりつけ型 (3 本斜)

MT-BK01, B22, 13 型

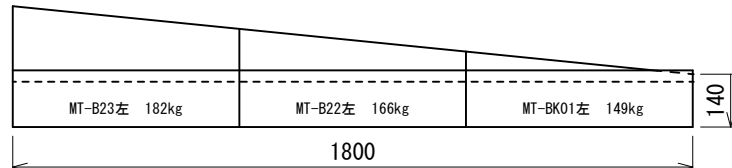
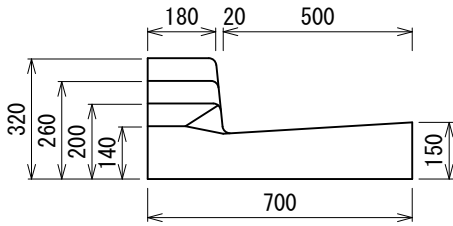

MD-BK0型 139kg

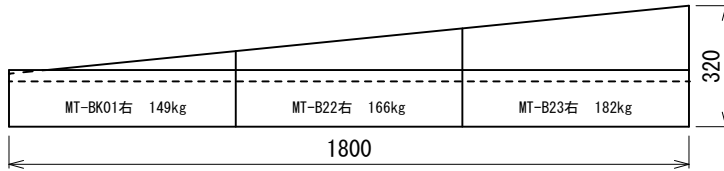
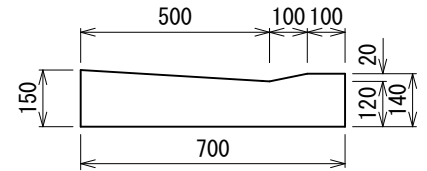

MT-B21, 22, 23 型

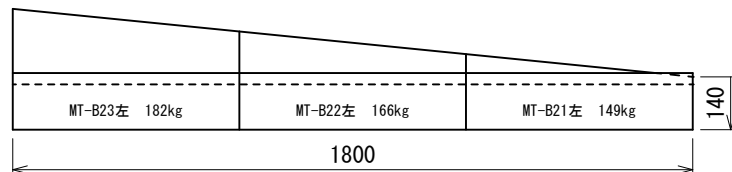
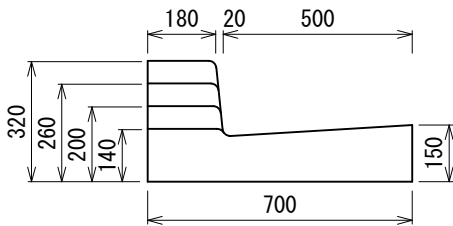

MD-B20型 140kg

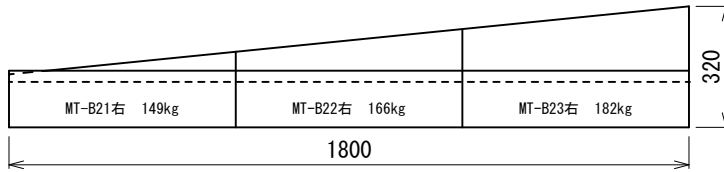
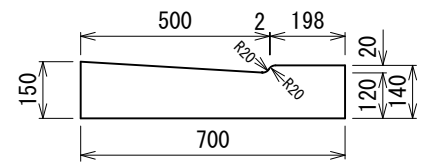

MT-B51, 12, 13 型

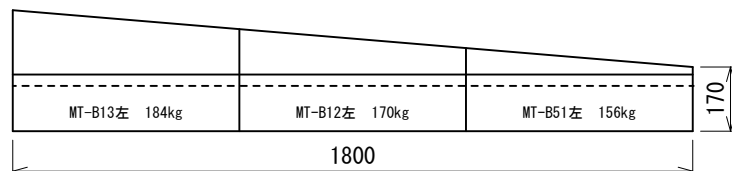
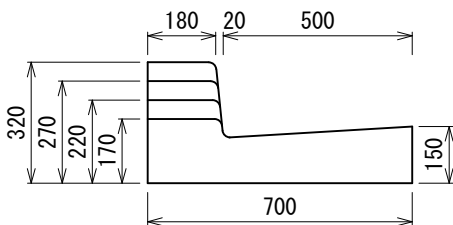

MD-B50型 149kg

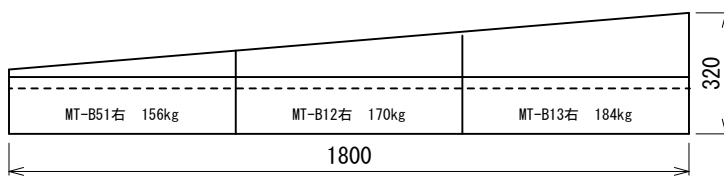
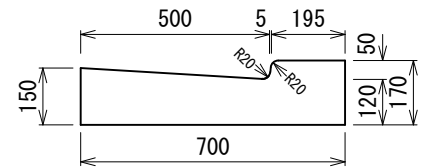

MT-B11, 12, 13 型

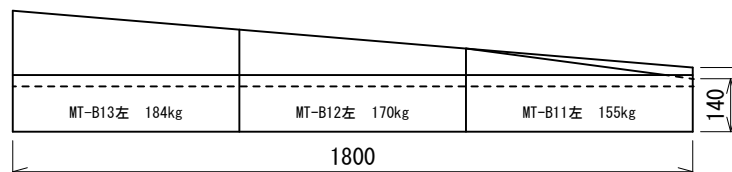
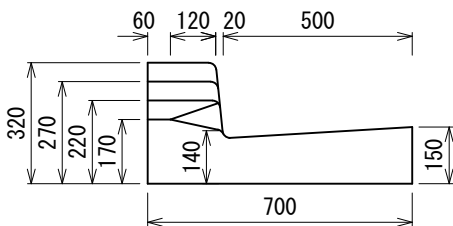

MD-B1型 146kg

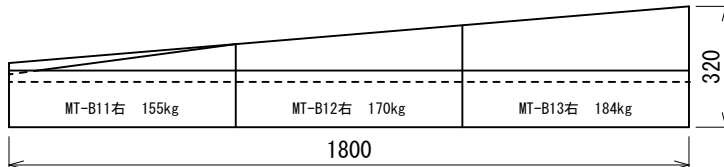
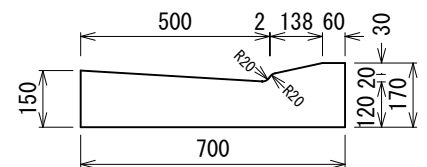

国交省 L 形 縁塊・すりつけ型 (斜) 及び切り下げ型 (平)

I 型 1 本すりつけ型 (1 本斜)

マウントアップ型

MT-AF25型 145kg

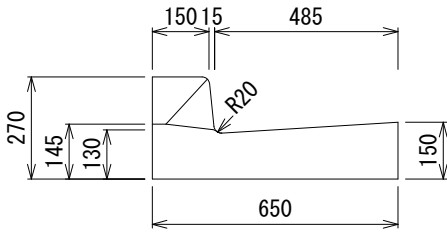

フラット型

FT-AF25型 142kg

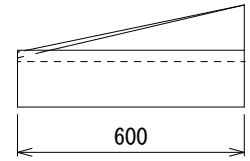
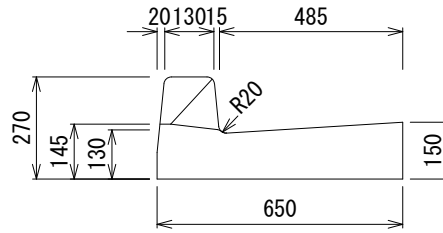

MT-BF25型 166kg

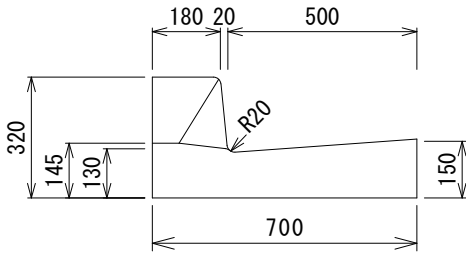

FT-BF25型 161kg

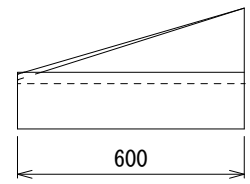
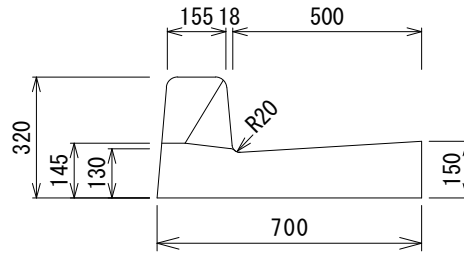

切り下げ型 (ハリアフリ型)

MD-AF25型 433kg (130kg)

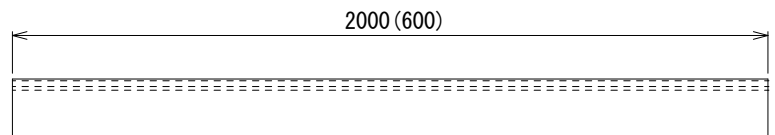
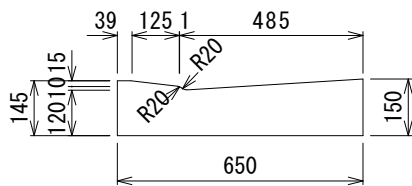

MD-BF25型 468kg (140kg)

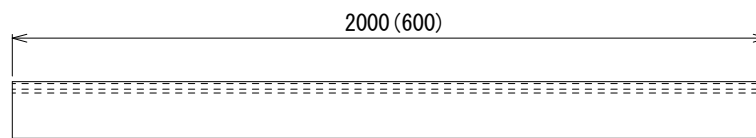
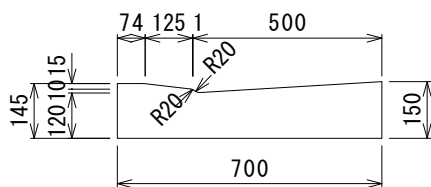

切り下げ型 R (ハリアフリ型)

MD-AF25型 141~134kg

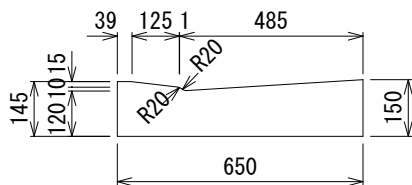

縁塊切り下げ型

(ハリアフリ型)

MD-AF25型 103kg
(MD-BF25型 115kg)

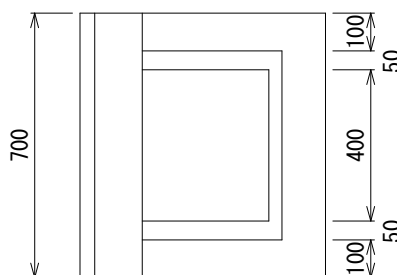
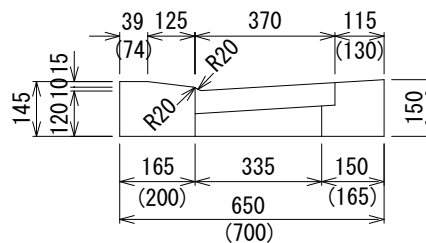

グレーチング

普通目 T-25 15.2kg

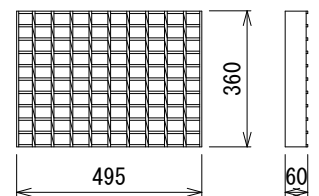

細目スバリ止め T-25 20.4kg

