

横断側溝 (TV型) 及びグレ付消音側溝

本体 (T-14)

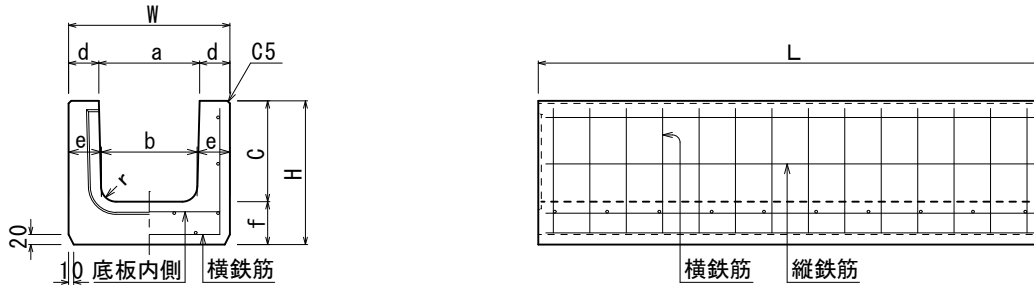

寸法及び配筋表

呼び名	寸法 (mm)										配筋						重量 (kg)
											横鉄筋			縦鉄筋			
	a	b	c	d	e	f	r	H	W	L	底板内側 径(φ)	本数	外側 径(φ)	本数	径(φ)	本数	
TV150	150	140	150	60	65	85	30	235	270	2000	D6	10	D6	26	D6	10	201
TV200	200	190	200	60	65	85	30	285	320	2000	D6	12	D6	30	D6	10	251

スリットタイプ

スリット型 (T-2用)

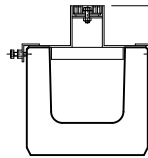

スリット蓋

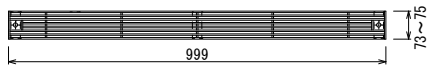

スリット型 (T-14用)

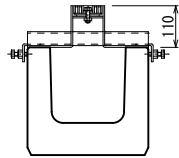

グレーチングタイプ

ホルト固定型

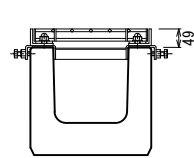

グレ蓋

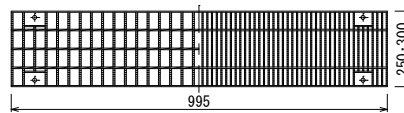

化粧蓋タイプ

充填型

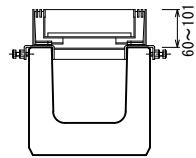

化粧蓋

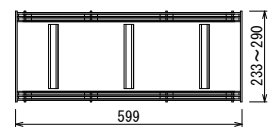

グレ付消音側溝本体

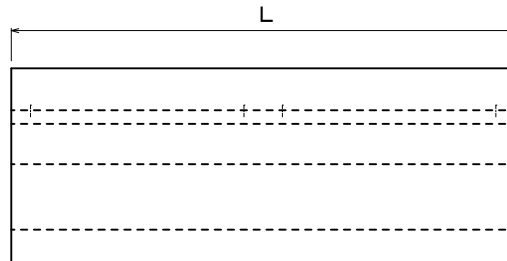
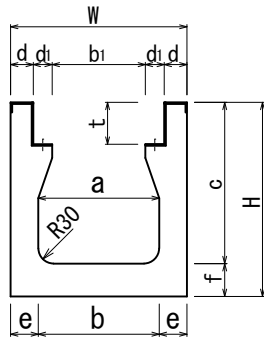

グレーチング蓋

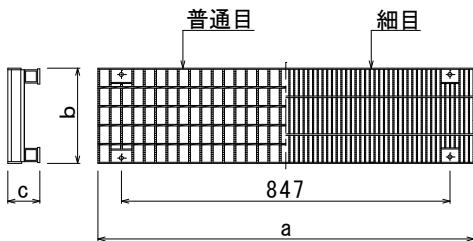

グレーチング寸法表

呼び	寸法 (mm)			重量 (kg)	
	a	b	c	普通目	細目
240	995	252	85	21.3	26.7
300	995	312	91	29.3	38.4

本体寸法表

呼び名	寸法 (mm)											重量 (kg)	
	a	b	b1	c	d	d1	e	f	t	H	W		L
240A	240	240	185	320	45	37.5	55	65	83	385	350	2000	308
240B	240	240	185	380	45	37.5	55	65	83	445	350	2000	340
240C	240	222	185	480	45	37.5	64	65	83	545	350	2000	407
240D	240	216	185	580	45	37.5	67	70	83	650	350	2000	480
240E	240	210	185	680	45	37.5	70	75	83	755	350	2000	555
300A	300	300	245	390	50	37.5	60	70	91	460	420	2000	397
300B	300	300	245	490	50	37.5	60	70	91	560	420	2000	455
300C	300	273	245	590	50	37.5	73.5	70	91	660	420	2000	542
300D	300	266	245	690	50	37.5	77	75	91	765	420	2000	629
300E	300	259	245	790	50	37.5	80.5	80	91	870	420	2000	702
300F	300	252	245	890	50	37.5	84	85	91	975	420	2000	779

横断側溝 (TRG型) 及び横断側溝柵

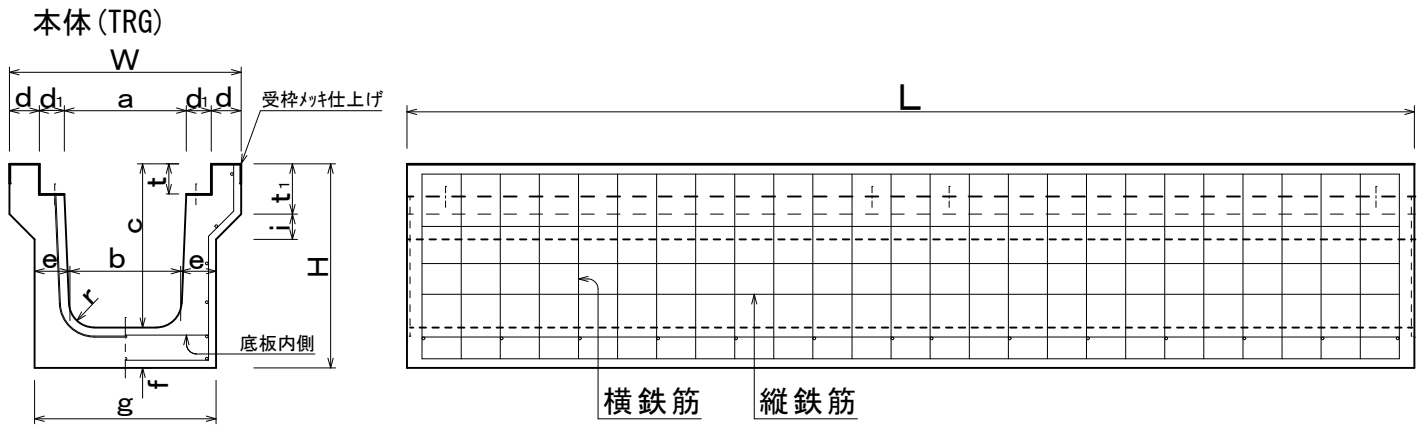

寸法及び配筋表

呼び名	寸法 (mm)															配筋				重量 (kg)			
	a	b	c	d	d ₁	e	f	g	i	t	t ₁	r	H	W	L	横鉄筋		縦鉄筋					
																底版内側 径 (mm)	本数	外側 径 (mm)	本数		径 (mm)	本数	
TRG	240	242	220	325	60	49	70	80	360	50	60	100	50	405	460	2000	D6	14	D6	26	6.0	13	371
	300	302	260	385	70	54	85	80	430	50	65	100	50	465	550	2000	D6	14	D6	28	6.0	13	502
	360	362	310	445	75	49	105	90	520	50	70	130	50	535	610	1000	D6	11	D10	11	6.0	13	339
	450	452	400	550	80	54	120	95	640	50	85	150	70	645	720	2000	D6	22	D10	22	6.0	16	910

固定式グレーチングふた

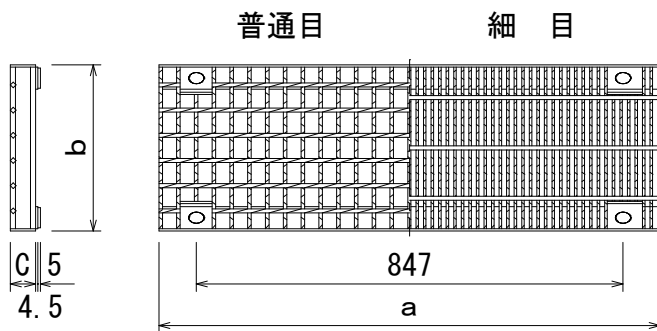

寸法表

呼び	寸法 (mm)			重量 (kg)	
	a	b	c	普通目	細目
240	995	330	50	26.8	39.7
300	995	400	55	34.0	50.1
360	995	450	60	41.1	72.5
450	995	550	75	58.2	83.3

横断側溝柵 240用 (309kg)

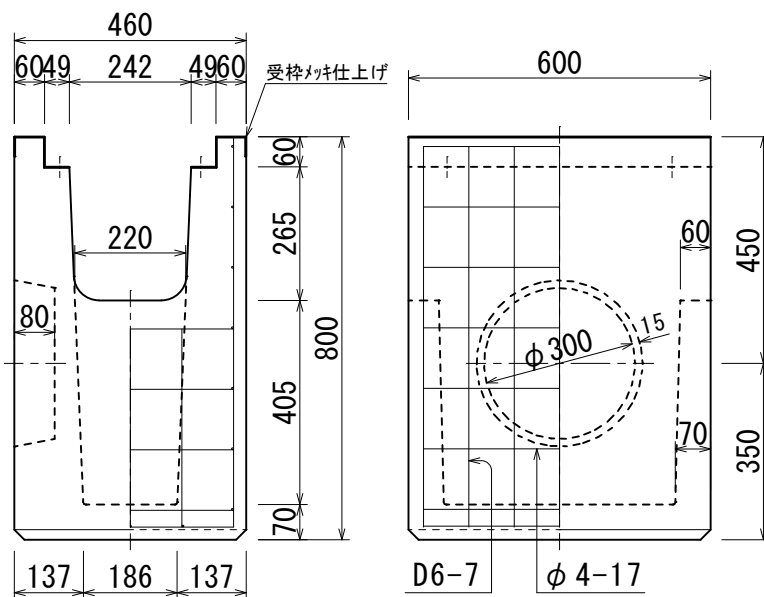

固定式グレーチングふた

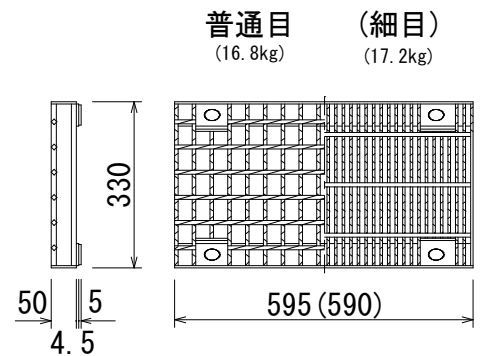

横断側溝 (TWG240・TJG250・THG250)

本体 TWG240 624kg

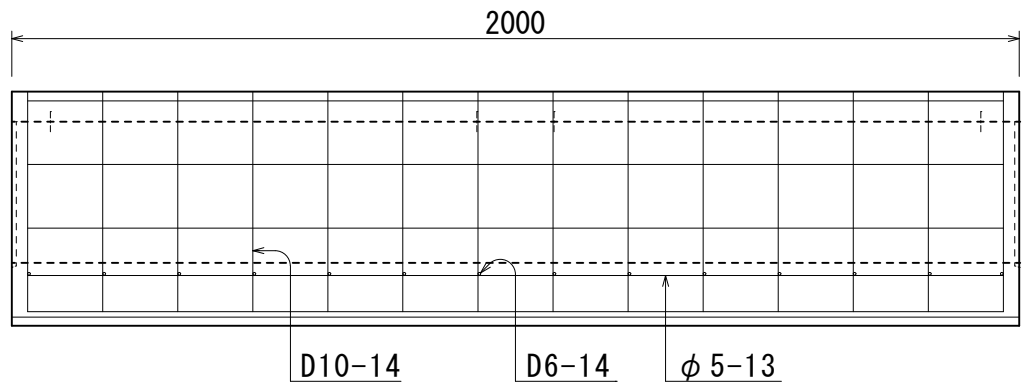
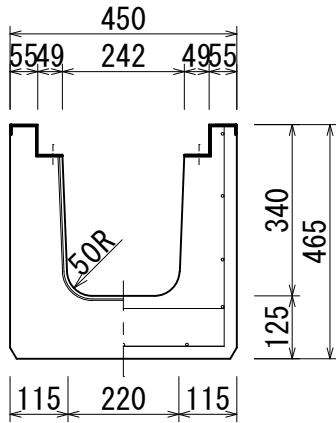

本体 TJG250 640kg

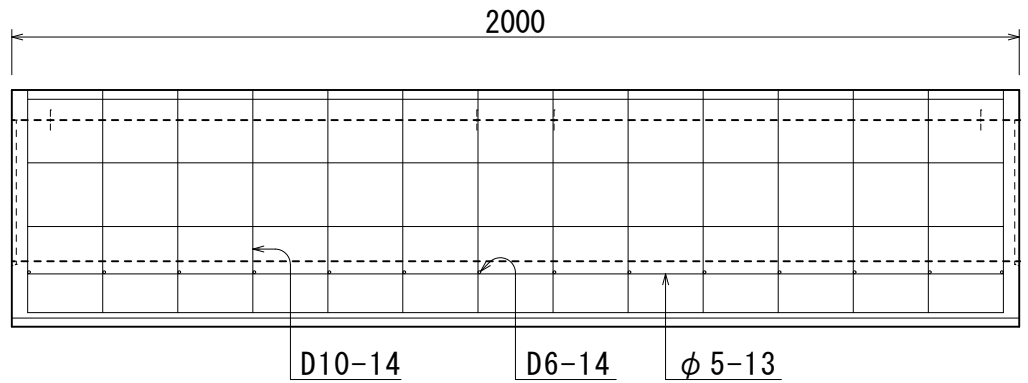
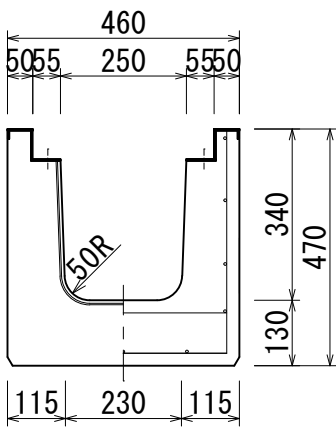

本体 THG250 904kg

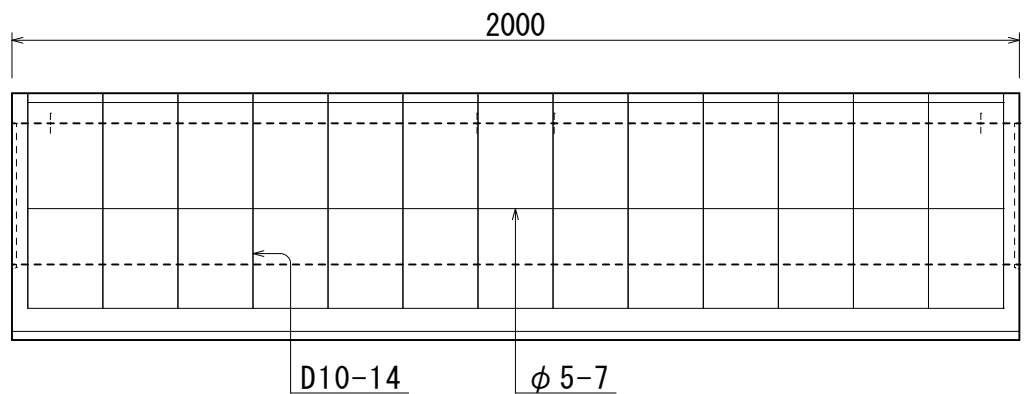
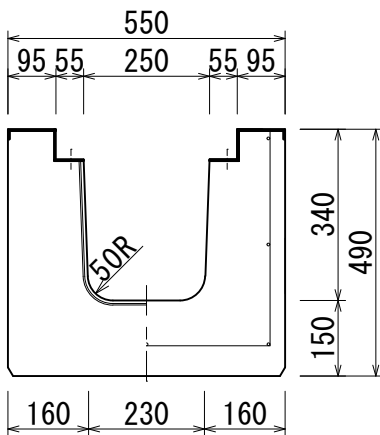

固定式グレーチングふた

普通目 細目

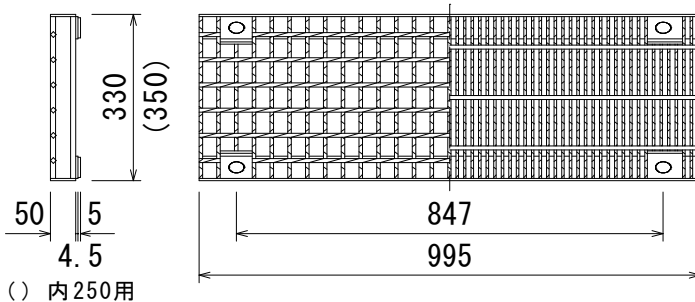

重量表 (kg)

呼び	普通目	細目
240	26.8	39.7
250	28.4	42.4

横断側溝 (TWT240・TJT250・THT250)

本体 TWT240 635kg

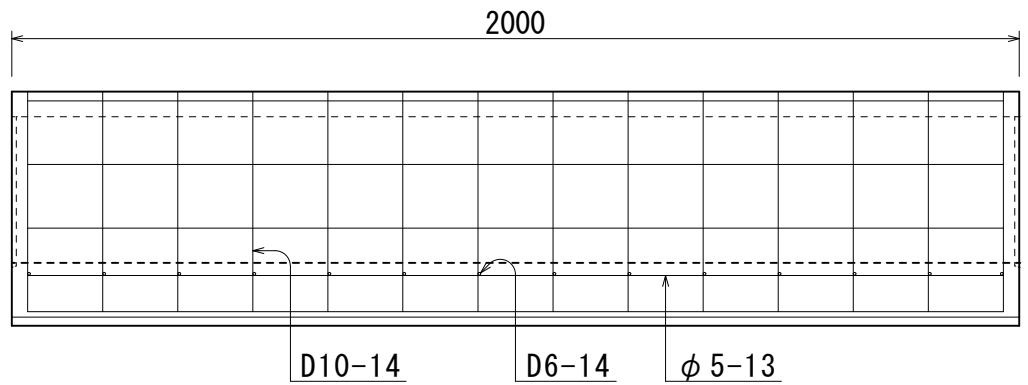
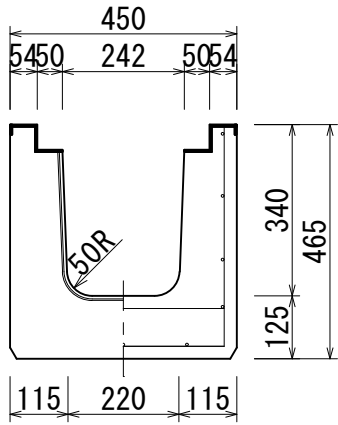

本体 TJT250 654kg

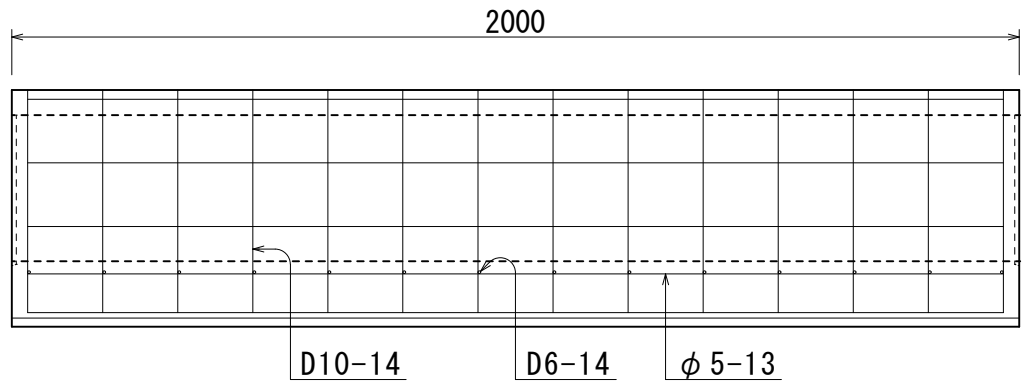
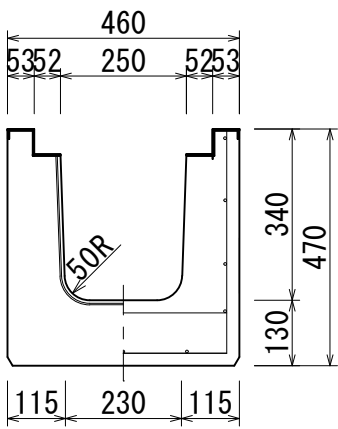

本体 THT250 919kg

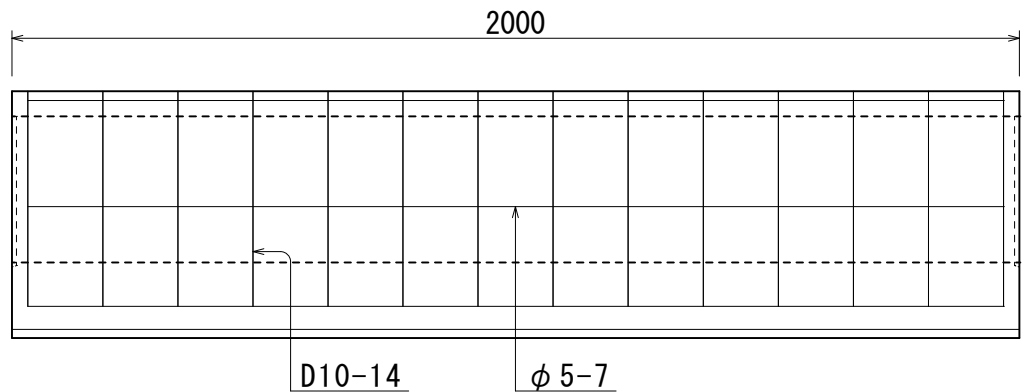
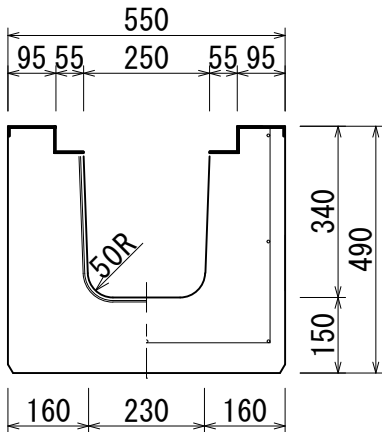

トライボット式グレーチングふた

普通目 細目

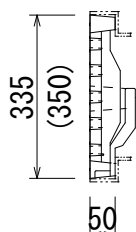

() 内250用

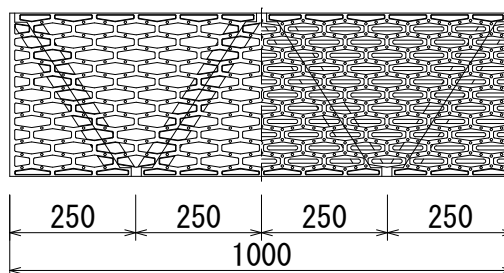

重量表 (kg/m)

呼び	普通目	細目
240	34	37
250	38	39.6

消音可変横断側溝 (門型)

側溝本体

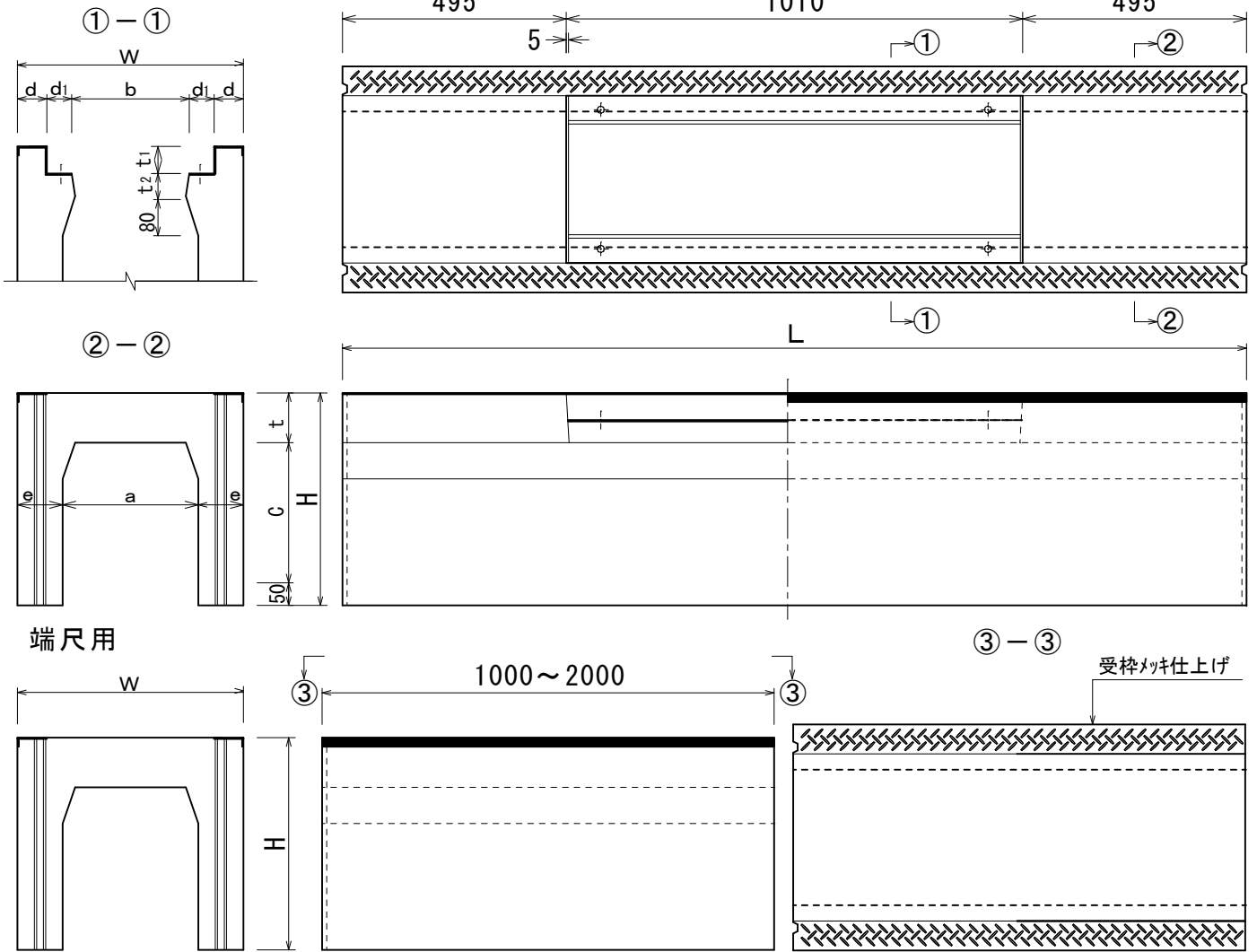

本体寸法表

呼び	寸法 (mm)											重量 (kg)		
	a	b	c	d	d ₁	e	t	t ₁	t ₂	H	W		L	
本体	300A	300	260	300	65	55	100	110	60	50	460	500	2000	539 (624)
	300B	300	260	400	65	55	100	110	60	50	560	500	2000	637 (722)
	300C	300	260	500	65	55	100	110	60	50	660	500	2000	735 (820)
	300D	300	260	600	65	55	100	110	60	50	760	500	2000	833 (918)
	300E	300	260	700	65	55	100	110	60	50	860	500	2000	931 (1016)
	300F	300	260	800	65	55	100	110	60	50	960	500	2000	1029 (1114)
	300G	300	260	900	65	55	100	110	60	50	1060	500	2000	1127 (1212)
	300H	300	260	1000	95	55	130	110	60	50	1160	560	2000	1564 (1650)
	300I	300	260	1100	95	55	130	110	60	50	1260	560	2000	1692 (1776)
	300J	300	260	1200	95	55	130	110	60	50	1360	560	2000	1819 (1904)

* 端尺用は②-②断面のL=2000製品

* ()内は端尺用重量

固定式グレーチング

普通目

細目

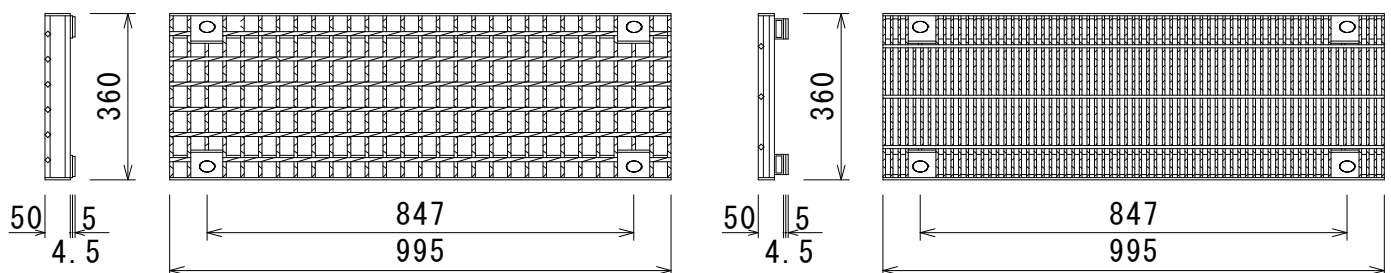

重耐用横断側溝 (THG型)

本体

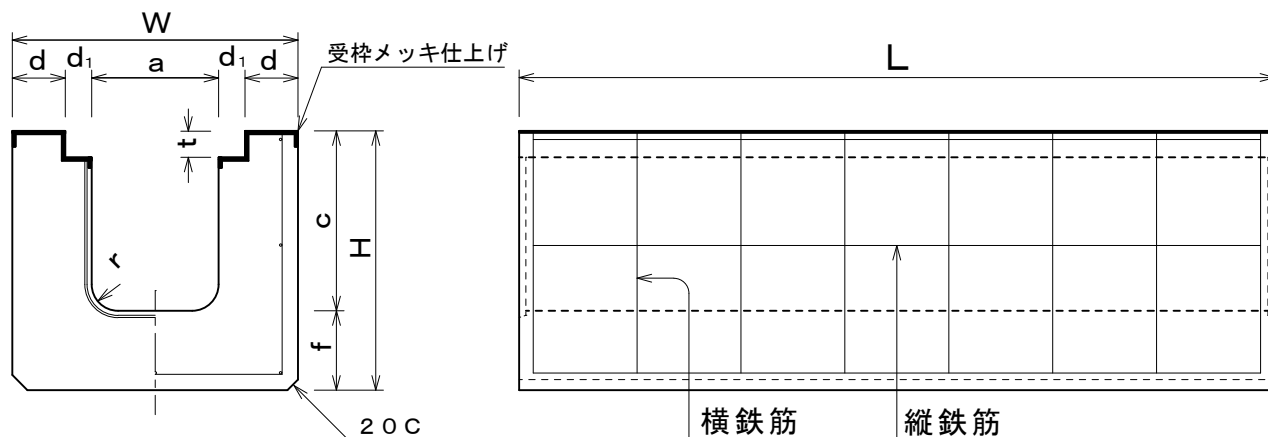

寸法及び配筋表

呼び	寸法 (mm)										配筋				重量 (kg)
	a	c	d	d ₁	f	t	r	W	H	L	横鉄筋		縦鉄筋		
											径 (mm)	本数	径 (mm)	本数	
THG240A	240	340	100	50	150	60	50	540	490	2000	D10	12	5.0	7	895
THG240B	240	400	100	50	150	60	50	540	550	2000	D10	12	5.0	8	983
THG240C	240	500	100	50	150	60	50	540	650	2000	D10	12	5.0	9	1130
THG240D	240	600	100	50	150	60	50	540	750	2000	D10	12	5.0	10	1277
THG240E	240	700	100	50	150	60	50	540	850	2000	D10	12	5.0	11	1424
THG240F	240	800	100	50	150	60	50	540	950	2000	D10	12	5.0	12	1571
THG240G	240	900	100	50	150	60	50	540	1050	2000	D10	12	5.0	13	1718
THG300A	300	340	95	55	150	65	50	600	490	2000	D10	12	5.0	7	934
THG300B	300	400	95	55	150	65	50	600	550	2000	D10	12	5.0	8	1022
THG300C	300	500	95	55	150	65	50	600	650	2000	D10	12	5.0	9	1169
THG300D	300	600	95	55	150	65	50	600	750	2000	D10	12	5.0	10	1316
THG300E	300	700	95	55	150	65	50	600	850	2000	D10	12	5.0	11	1463
THG300F	300	800	95	55	150	65	50	600	950	2000	D10	12	5.0	12	1610
THG300G	300	900	95	55	150	65	50	600	1050	2000	D10	12	5.0	13	1757
THG300H	300	1000	95	55	150	65	50	600	1150	2000	D10	12	5.0	14	1904
THG300I	300	1100	95	55	150	65	50	600	1250	2000	D10	14	5.0	15	2051
THG400A	400	400	95	55	150	75	50	700	550	2000	D13	10	6.0	9	1091
THG400B	400	500	95	55	150	75	50	700	650	2000	D13	10	6.0	10	1238
THG400C	400	600	95	55	150	75	50	700	750	2000	D13	10	6.0	11	1385
THG400D	400	700	95	55	150	75	50	700	850	2000	D13	10	6.0	12	1532
THG400E	400	800	95	55	150	75	50	700	950	2000	D13	10	6.0	13	1679
THG400F	400	900	95	55	150	75	50	700	1050	2000	D13	10	6.0	14	1826
THG400G	400	1000	95	55	150	75	50	700	1150	2000	D13	10	6.0	15	1973
THG500A	500	600	95	55	150	85	50	800	750	2000	D13	12	6.0	11	1454
THG500B	500	700	95	55	150	85	50	800	850	2000	D13	12	6.0	12	1601
THG500C	500	800	95	55	150	85	50	800	950	2000	D13	12	6.0	13	1748
THG500D	500	900	95	55	150	85	50	800	1050	2000	D13	12	6.0	14	1895
THG500E	500	1000	95	55	150	85	50	800	1150	2000	D13	12	6.0	15	2042
THG600A	600	700	95	55	150	100	50	900	850	2000	D13	14	6.0	13	1674
THG600B	600	800	95	55	150	100	50	900	950	2000	D13	14	6.0	14	1821
THG600C	600	900	95	55	150	100	50	900	1050	2000	D13	14	6.0	15	1968
THG600D	600	1000	95	55	150	100	50	900	1150	2000	D13	14	6.0	16	2115
THG600E	600	1100	95	55	150	100	50	900	1250	2000	D13	14	6.0	17	2262

固定式グレーチングふた

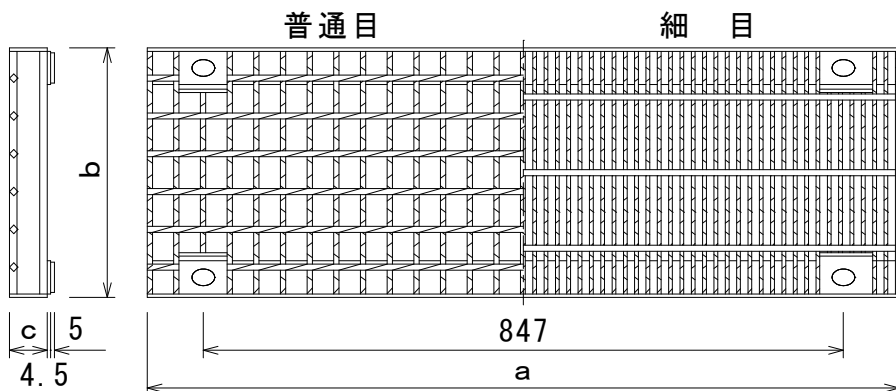

寸法表

呼び	寸法 (mm)			重量 (kg)	
	a	b	c	普通目	細目
240	995	330	50	26.8	39.7
300	995	400	55	34.0	50.1
400	995	500	65	47.3	75.1
500	995	600	75	63.0	90.7
600	995	700	90	82.1	114.8

重耐用横断側溝 (THT型)

本体

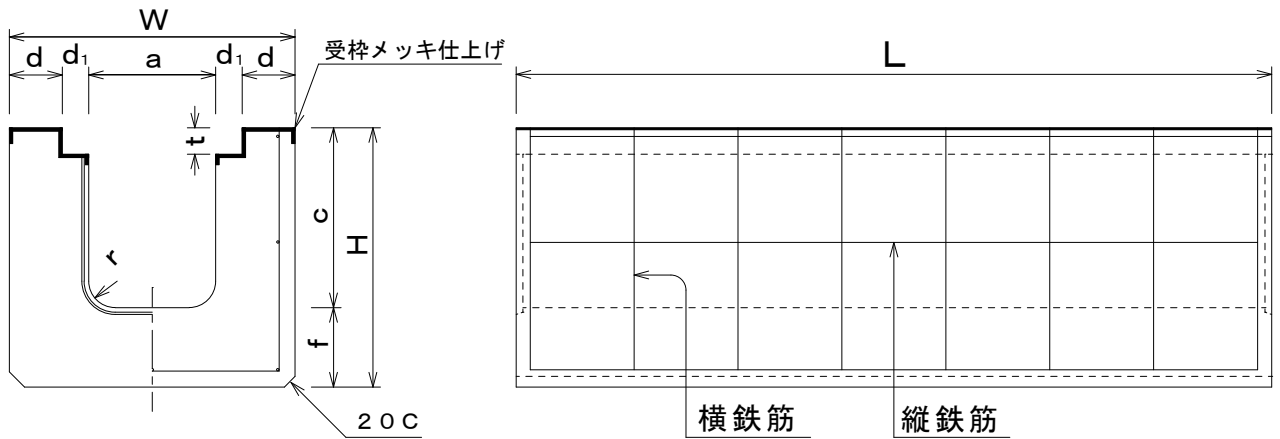

寸法及び配筋表

呼び	寸法 (mm)										配筋				重量 (kg)
	a	c	d	d ₁	f	t	r	W	H	L	横鉄筋		縦鉄筋		
											径 (mm)	本数	径 (mm)	本数	
THT240A	240	340	100	50	150	50	50	540	490	2000	D10	12	5.0	7	899
THT240B	240	400	100	50	150	50	50	540	550	2000	D10	12	5.0	8	987
THT240C	240	500	100	50	150	50	50	540	650	2000	D10	12	5.0	9	1134
THT240D	240	600	100	50	150	50	50	540	750	2000	D10	12	5.0	10	1281
THT240E	240	700	100	50	150	50	50	540	850	2000	D10	12	5.0	11	1428
THT240F	240	800	100	50	150	50	50	540	950	2000	D10	12	5.0	12	1575
THT240G	240	900	100	50	150	50	50	540	1050	2000	D10	12	5.0	13	1722
THT300A	300	340	98	52	150	50	50	600	490	2000	D10	12	5.0	7	943
THT300B	300	400	98	52	150	50	50	600	550	2000	D10	12	5.0	8	1031
THT300C	300	500	98	52	150	50	50	600	650	2000	D10	12	5.0	9	1178
THT300D	300	600	98	52	150	50	50	600	750	2000	D10	12	5.0	10	1325
THT300E	300	700	98	52	150	50	50	600	850	2000	D10	12	5.0	11	1472
THT300F	300	800	98	52	150	50	50	600	950	2000	D10	12	5.0	12	1619
THT300G	300	900	98	52	150	50	50	600	1050	2000	D10	12	5.0	13	1766
THT300H	300	1000	98	52	150	50	50	600	1150	2000	D10	12	5.0	14	1913
THT300I	300	1100	98	52	150	50	50	600	1250	2000	D10	14	5.0	15	2060
THT400A	400	400	98	52	150	50	50	700	550	2000	D13	10	6.0	9	1104
THT400B	400	500	98	52	150	50	50	700	650	2000	D13	10	6.0	10	1251
THT400C	400	600	98	52	150	50	50	700	750	2000	D13	10	6.0	11	1398
THT400D	400	700	98	52	150	50	50	700	850	2000	D13	10	6.0	12	1545
THT400E	400	800	98	52	150	50	50	700	950	2000	D13	10	6.0	13	1692
THT400F	400	900	98	52	150	50	50	700	1050	2000	D13	10	6.0	14	1839
THT400G	400	1000	98	52	150	50	50	700	1150	2000	D13	10	6.0	15	1986
THT500A	500	600	98	52	150	65	50	800	750	2000	D13	12	6.0	11	1464
THT500B	500	700	98	52	150	65	50	800	850	2000	D13	12	6.0	12	1611
THT500C	500	800	98	52	150	65	50	800	950	2000	D13	12	6.0	13	1758
THT500D	500	900	98	52	150	65	50	800	1050	2000	D13	12	6.0	14	1905
THT500E	500	1000	98	52	150	65	50	800	1150	2000	D13	12	6.0	15	2052
THT600A	600	700	98	52	150	65	50	900	850	2000	D13	14	6.0	13	1685
THT600B	600	800	98	52	150	65	50	900	950	2000	D13	14	6.0	14	1832
THT600C	600	900	98	52	150	65	50	900	1050	2000	D13	14	6.0	15	1979
THT600D	600	1000	98	52	150	65	50	900	1150	2000	D13	14	6.0	16	2126
THT600E	600	1100	98	52	150	65	50	900	1250	2000	D13	14	6.0	17	2273

トライポット式グレーチングふた

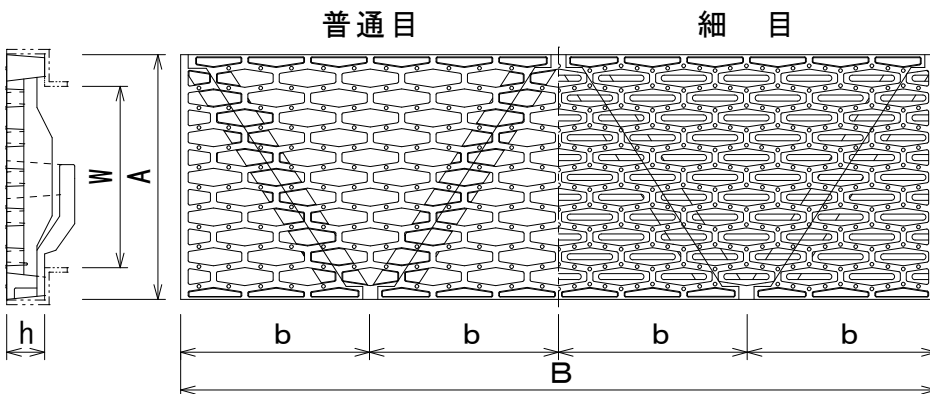

寸法表

呼び (W)	寸法 (mm)				重量 (kg/m)	
	A	b	B	h	普通目	細目
240	335	250	1000	50	34	37
300	400	250	1000	50	45	47.8
400	500	250	1000	50	59	63
500	600	333	1000	65	74	86.2
600	700	333	1000	65	85	96.5