

フレキャスト街きよ155型

一般用 688kg

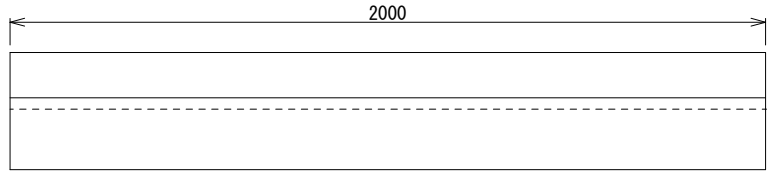

歩道用左右(斜) 1(2)3本斜

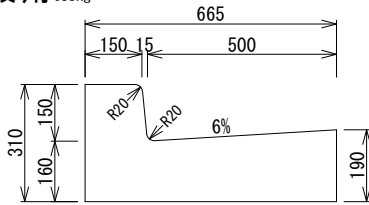
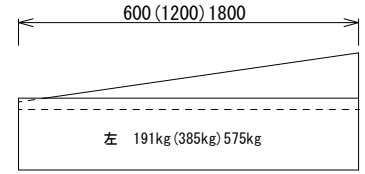
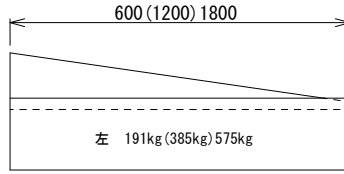
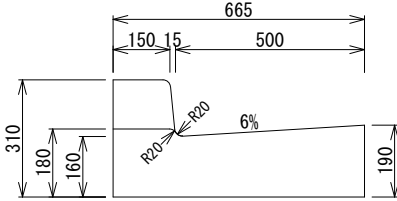

歩道用左右(斜) 1(2)3本斜L=2000

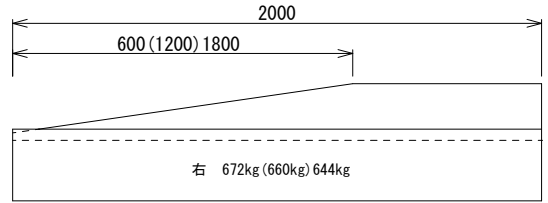
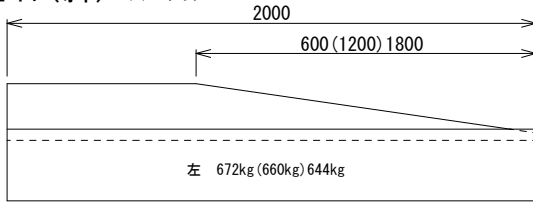

歩道用中(平) 586kg

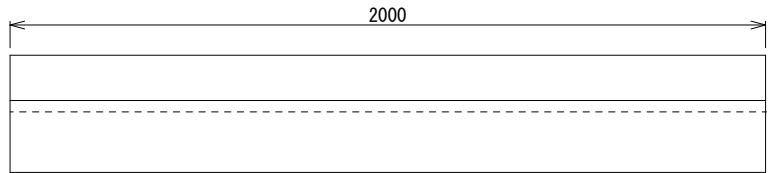
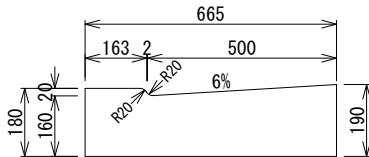

車道用左右(斜)

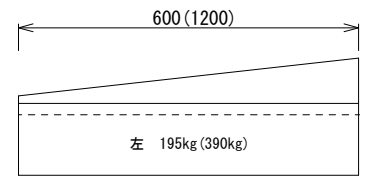
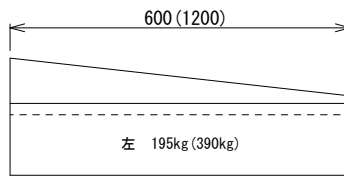
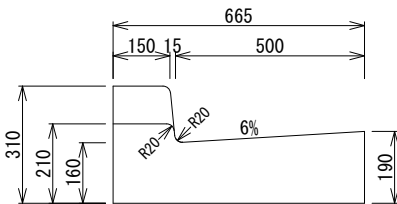

車道用左右(斜) 1(2)本斜L=2000

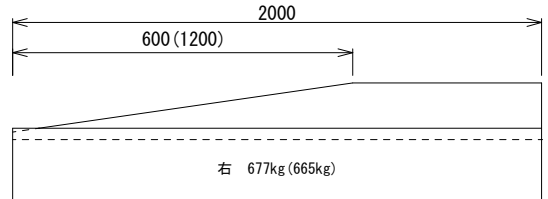
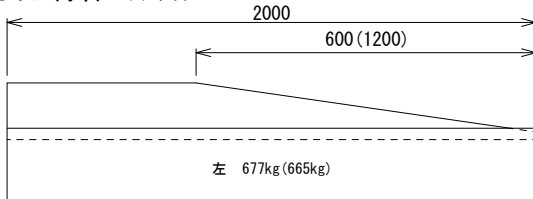

車道用中(平) 610kg

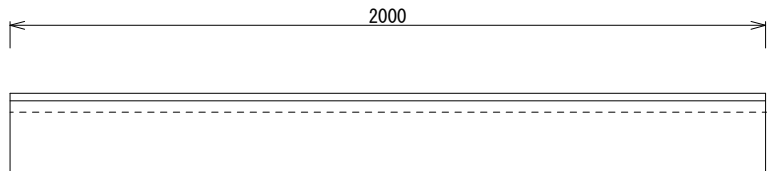
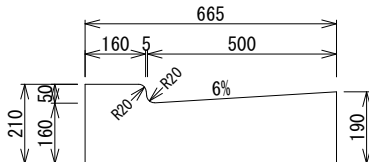

17°の表面突起模様も製造可
(スベリ止加工)

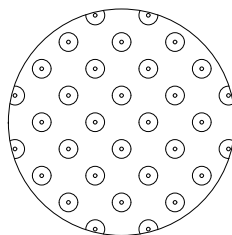

プレキャスト中央分離帯ブロック

ベース分離型

本体
617kg

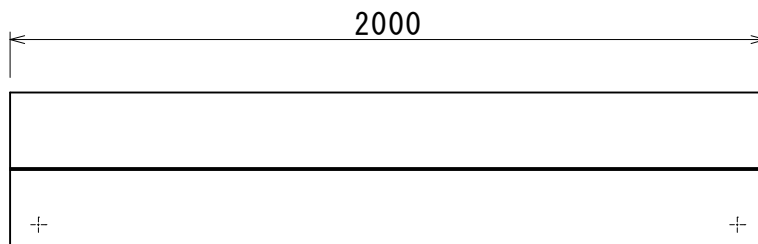
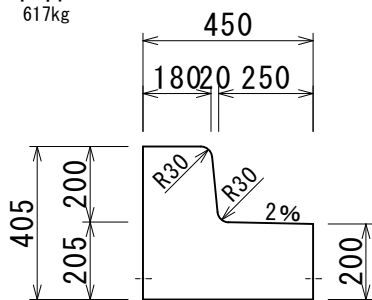

ベース
330kg

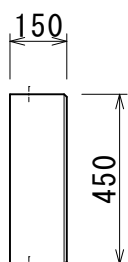

ベース一体型
938kg

