

千葉土木L 形及び縁塊

標準型

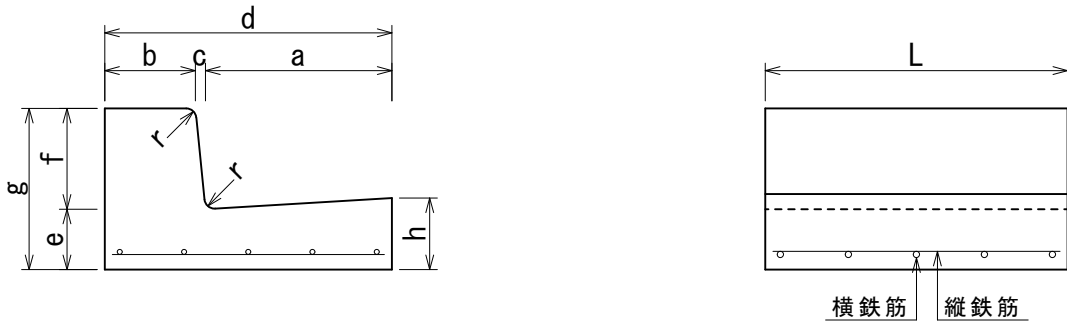

寸法及び配筋表

呼 び	寸 法 (mm)	寸 法 (mm)										配 筋				重 量 (kg)
		a	b	c	d	e	f	g	h	r	L	横鉄筋		縦鉄筋		
		呼び名	本数	呼び名	本数	呼び名	本数	呼び名	本数	呼び名	本数	呼び名	本数	呼び名	本数	
I 型	基本 570x270x600	405	150	15	570	120	150	270	145	20	600	D13	5	D10	5	143
	平 570x140x600 (MD-A20)	405	163	2	570	120	20	140	145	20	600	D13	5	D10	5	113
	平 570x170x600 (MD-A50)	405	160	5	570	120	50	170	145	20	600	D13	5	D10	5	120
II 型	基本 570x270x600	370	180	20	570	120	200	320	143	20	600	D13	5	D10	5	162
	平 570x140x600 (MD-B20)	370	198	2	570	120	20	140	143	20	600	D13	5	D10	5	113
	平 570x170x600 (MD-B50)	370	195	5	570	120	50	170	143	20	600	D13	5	D10	5	121

縁 塊

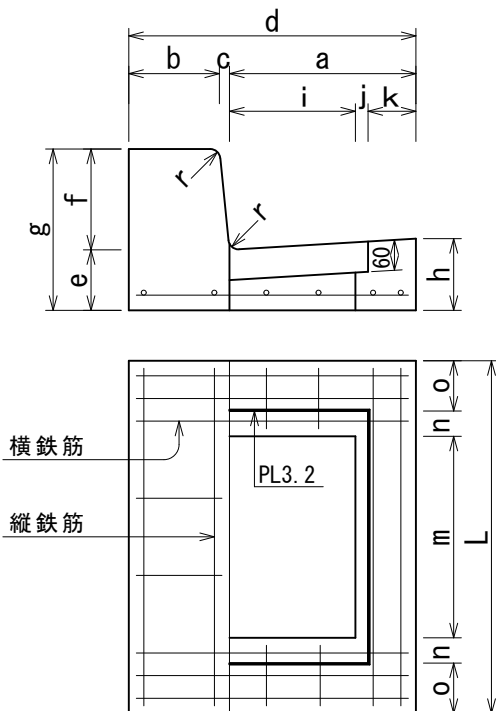

グレーチング T-25 9.8 kg

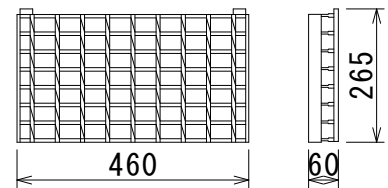

細目グレーチング T-25 14.1 kg

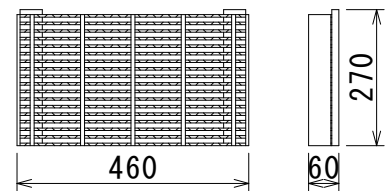

寸法及び配筋表

呼 び	寸 法 (mm)	寸 法 (mm)															配 筋				重 量 (kg)	
		a	b	c	d	e	f	g	h	i	j	k	m	n	o	r	L	横鉄筋		縦鉄筋		
		呼び名	本数	呼び名	本数	呼び名	本数	呼び名	本数	呼び名	本数	呼び名	本数	呼び名	本数	呼び名	本数	呼び名	本数	呼び名		本数
I 型	基本 570x270x600	405	150	15	570	120	150	270	145	25	130	400	35	115	20	700	D13	8	D10	6	132	
	平 570x140x600 (MD-A20)	405	163	2	570	120	20	140	145	25	130	400	35	115	20	700	D13	8	D10	6	97	
	平 570x170x600 (MD-A50)	405	160	5	570	120	50	170	145	25	130	400	35	115	20	700	D13	8	D10	6	105	
II 型	基本 570x270x600	370	180	20	570	120	200	320	143	25	95	400	35	115	20	700	D13	8	D10	6	153	
	平 570x140x600 (MD-B20)	370	198	2	570	120	20	140	143	25	95	400	35	115	20	700	D13	8	D10	6	95	
	平 570x170x600 (MD-B50)	370	195	5	570	120	50	170	143	25	95	400	35	115	20	700	D13	8	D10	6	105	

千葉土木型 L 形 縁塊・すりつけ型 (斜) 及び切り下げ型 (平)

I 型切り下げ型縁塊 (平)

MD-A1型 102kg

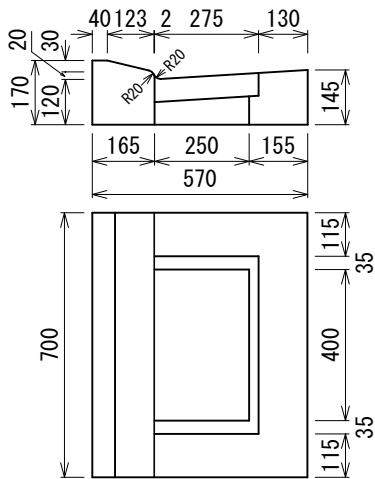

I 型 (II 型) 特殊縁塊

ブロック無縁塊 75kg (68kg)

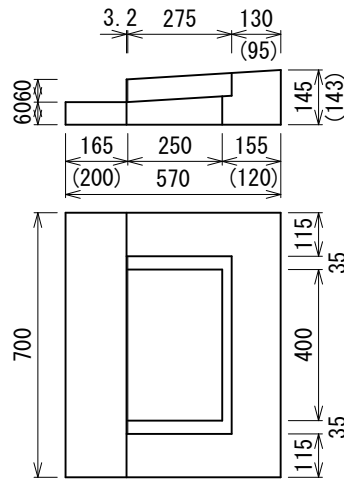

コの字縁塊 58kg (47kg)

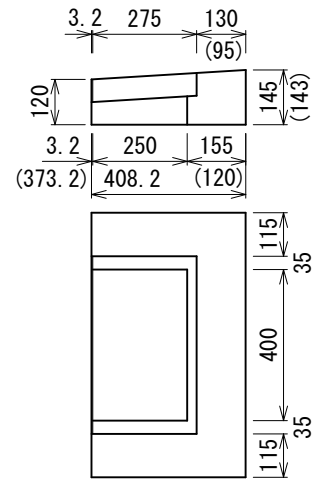

II 型切り下げ型縁塊 (平)

MD-BK0型 93kg

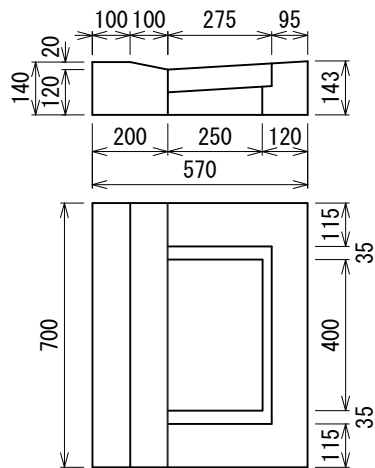

MD-B1型 102kg

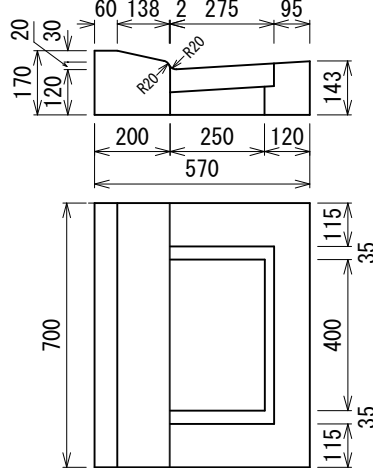

MD-B2型 112kg

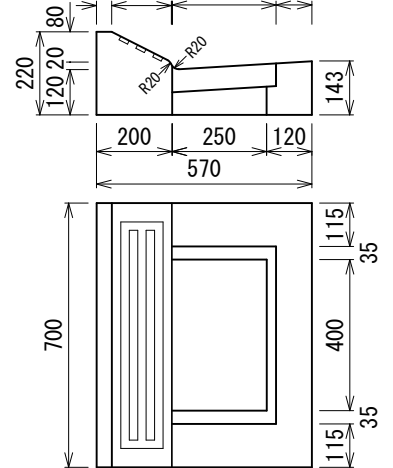

I 型 1 本すりつけ型 (1 本斜)

MT-A20型

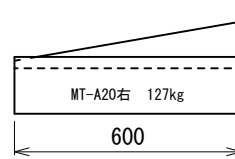
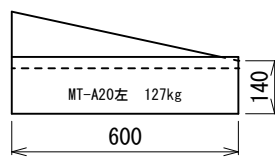
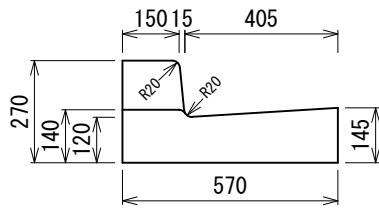

MT-A50型

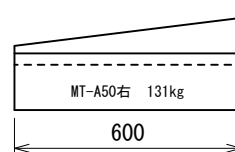
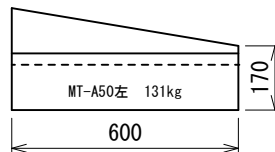
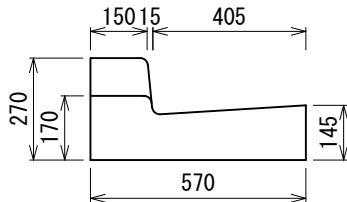

MT-A1型

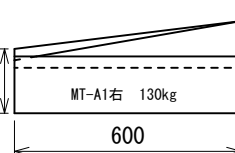
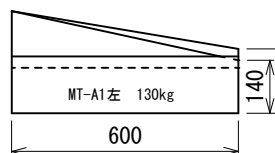
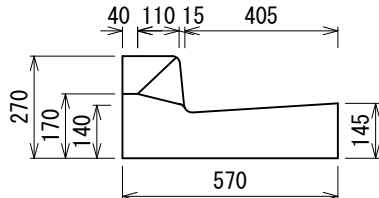

I 型切り下げ型 (平)

MD-A20型 113kg

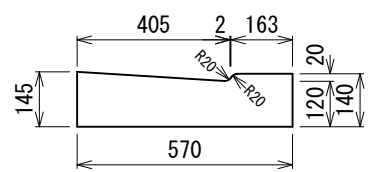

MD-A50型 120kg

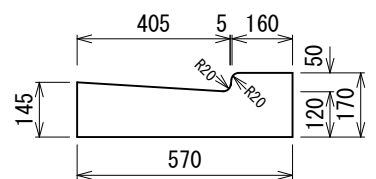

MD-A1型 117kg

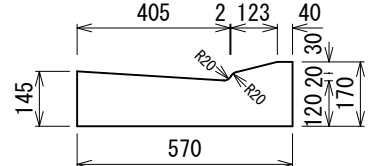

千葉土木型 L 形 すりつけ型 (斜) 及び切り下げ型 (平)

I 型 1 本すりつけ型 (1 本斜)

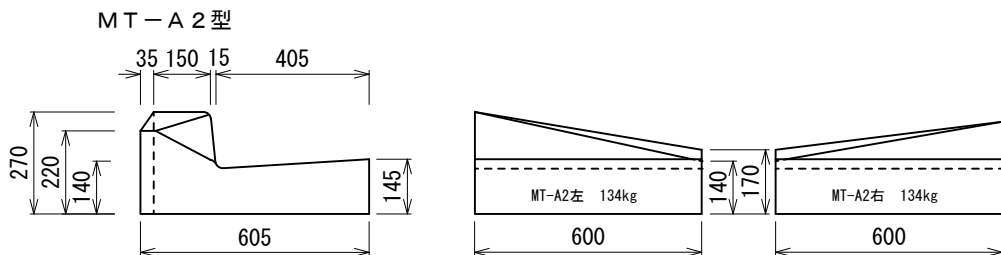

I 型切り下げ型 (平)

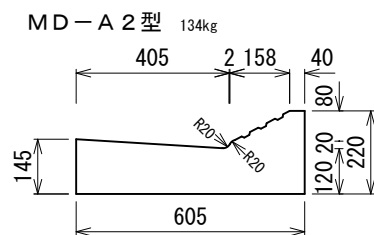

I 型 2 本すりつけ型 (2 本斜)

MT-A 2 1, 2 2 型

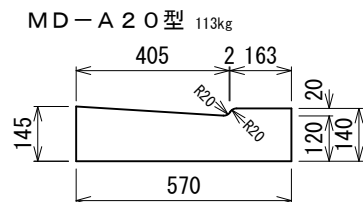
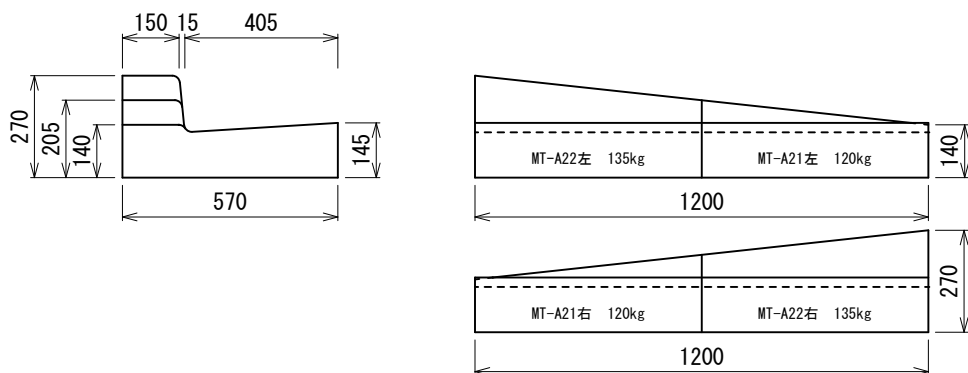

MT-A 5 1, 1 2 型

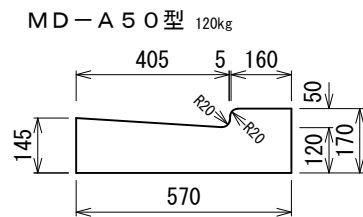
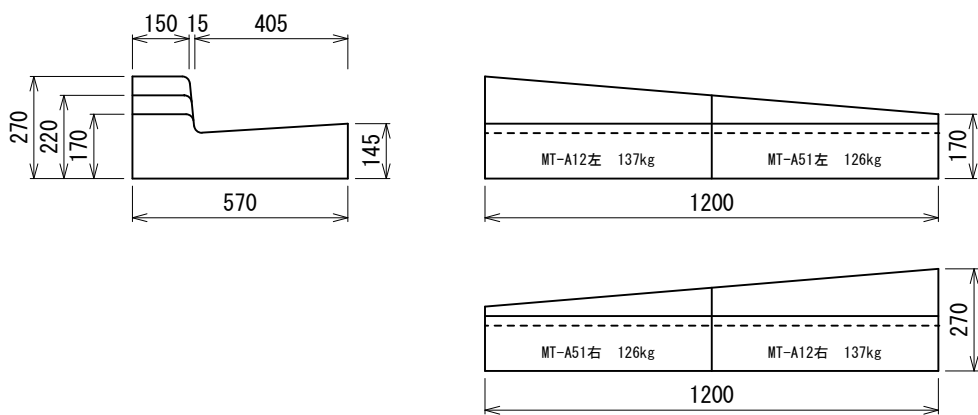

MT-A 1 1, 1 2 型

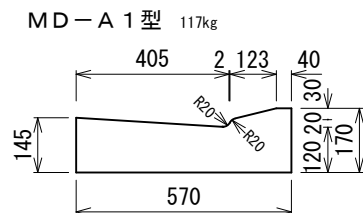
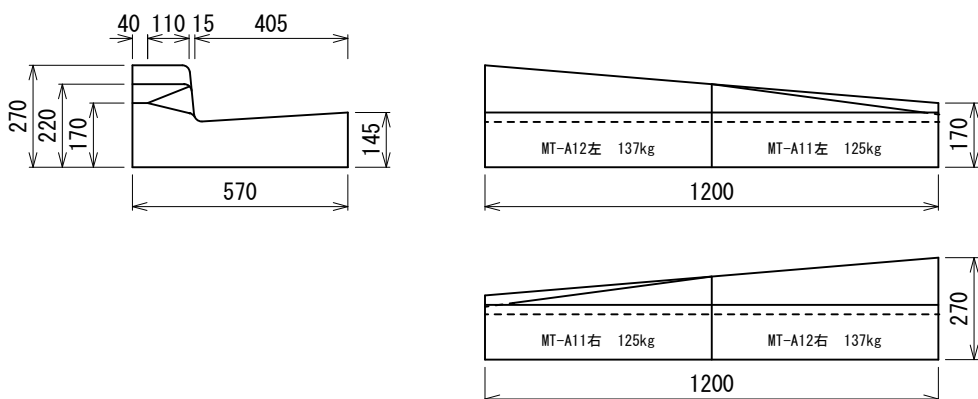

千葉土木型L形 すりつけ型 (斜) 及び切り下げ型 (平)

Ⅱ型 1本すりつけ型 (1本斜)

Ⅱ型 切り下げ型 (平)

MT-BK0型

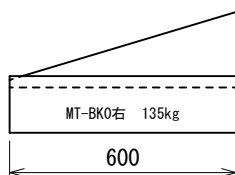
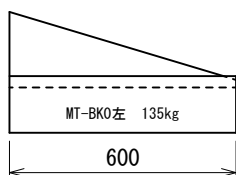
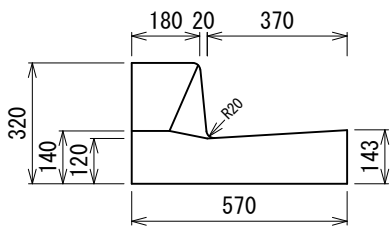

MD-BK0型 111kg

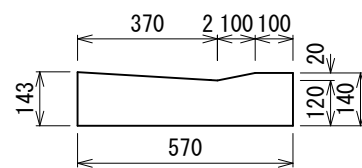

MT-B20型

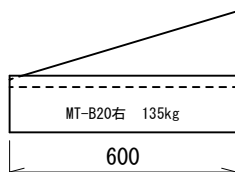
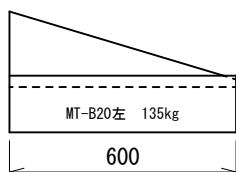
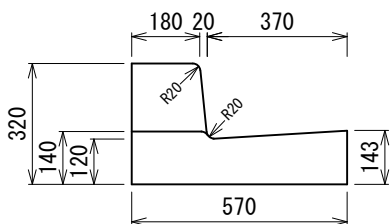

MD-B20型 113kg

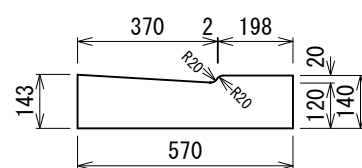

MT-B50型

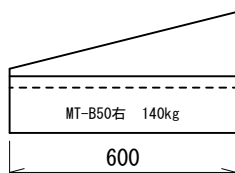
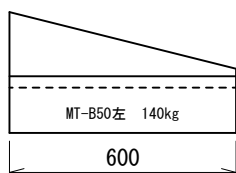
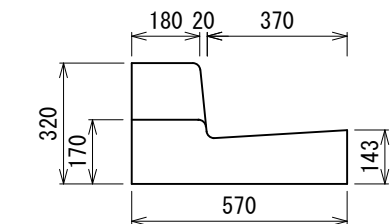

MD-B50型 121kg

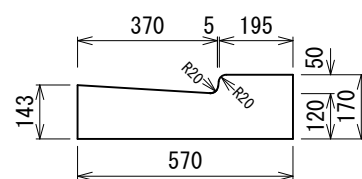

MT-B1型

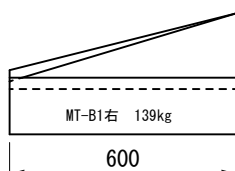
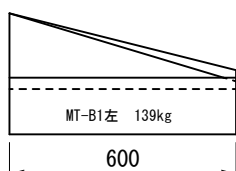
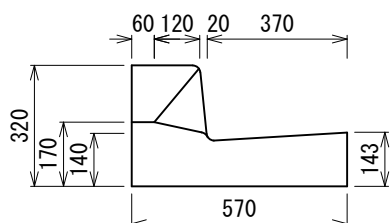

MD-B1型 119kg

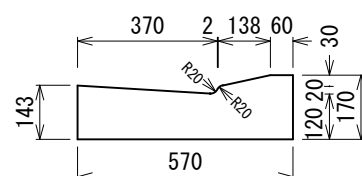

Ⅱ型 2本すりつけ型 (2本斜)

MT-B2, 13型

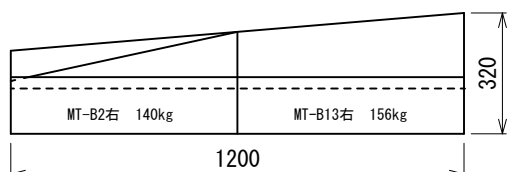
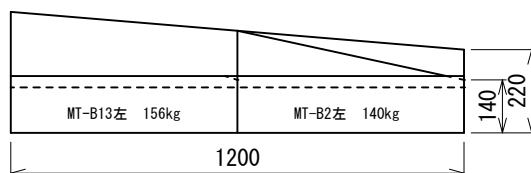
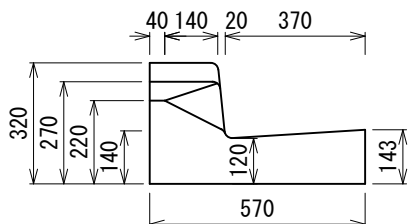

MD-B2型 127kg

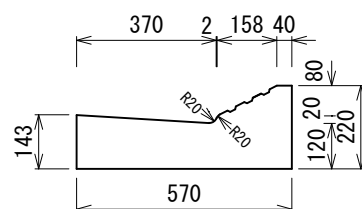

千葉土木型 L 型 すりつけ型 (斜) 及び切り下げ型 (平)

Ⅱ型 3本すりつけ型 (3本斜)

MT-BK01, B22, 23型

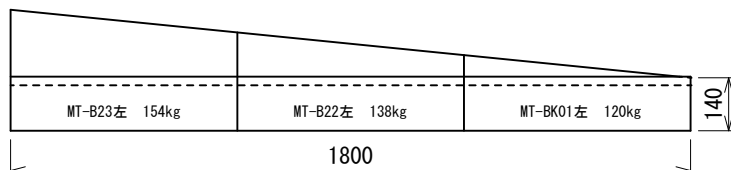
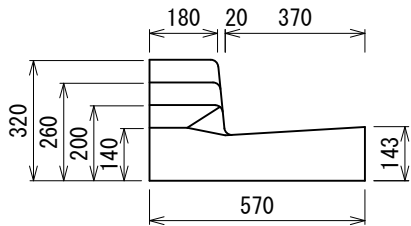

MD-BK0型 111kg

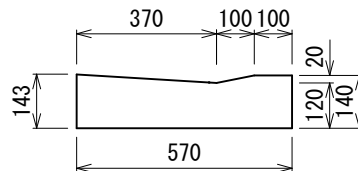

MT-B21, 22, 23型

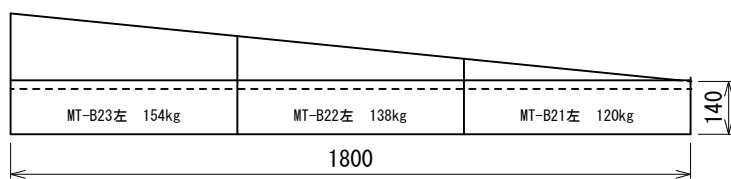
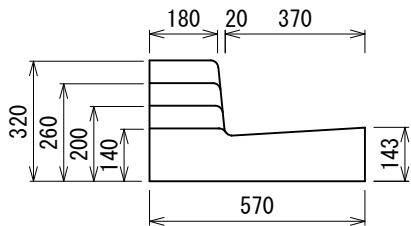

MD-B20型 113kg

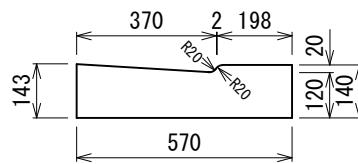

MT-B51, 12, 13型

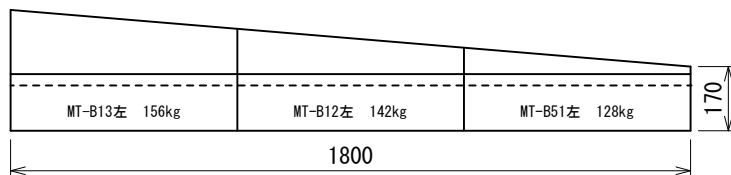
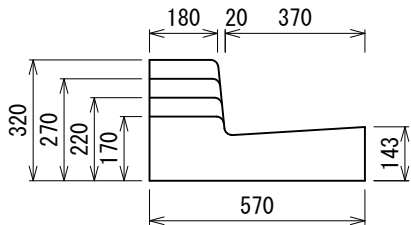

MD-B50型 121kg

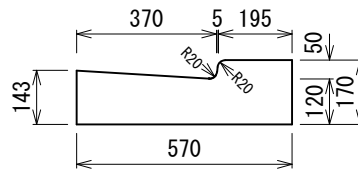

MT-B11, 12, 13型

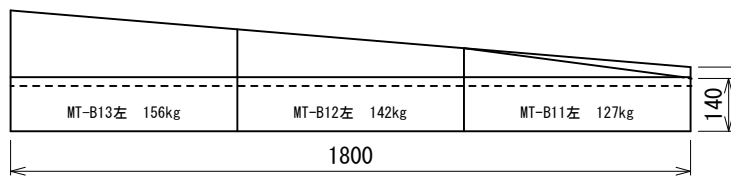
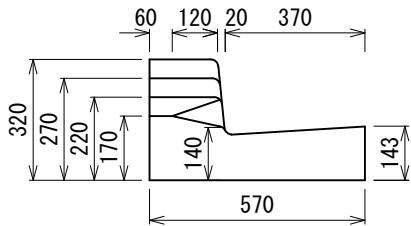

MD-B1型 119kg

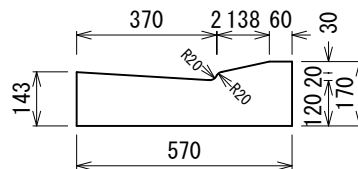

千葉土木 L 形 縁塊・すりつけ型 (斜) 及び切り下げ型 (平)

I 型 1 本すりつけ型 (1 本斜)

マウントアップ型
MT-AF25型

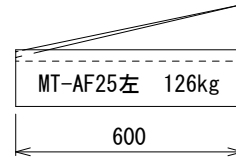
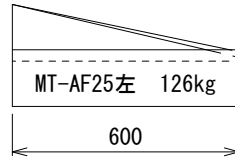
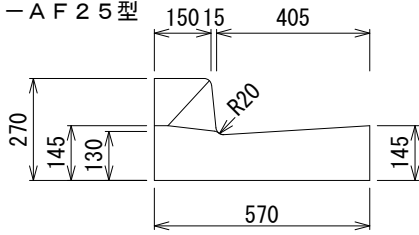

MT-BF25型

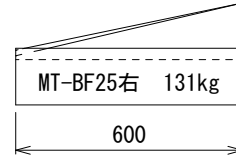
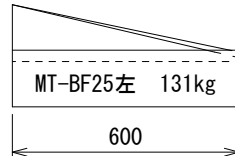
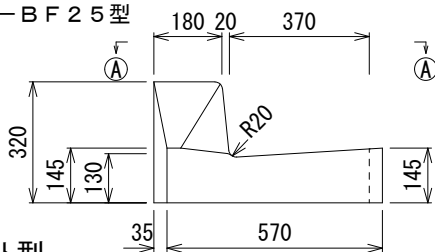

MT-BF25

①-①

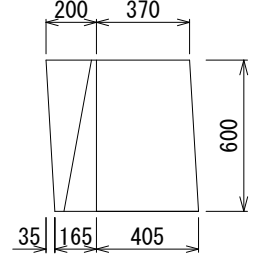

フラット型

FT-AF25型

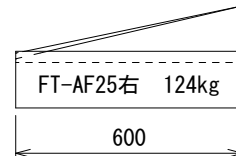
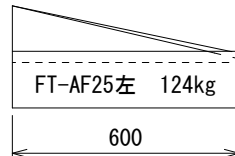
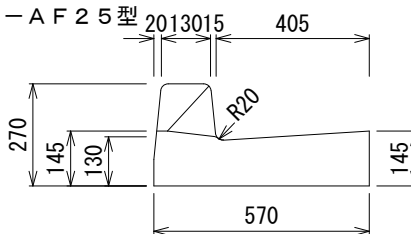

FT-BF25

②-②

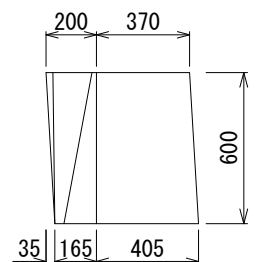

FT-BF25型

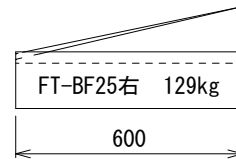
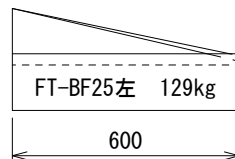
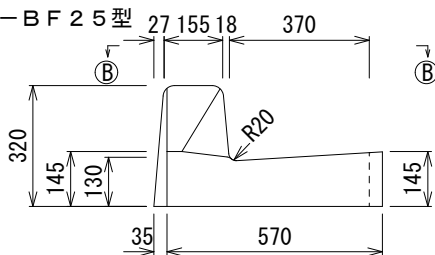

切り下げ型(ハリアリ型)

MD-AF25型 375kg(113kg)

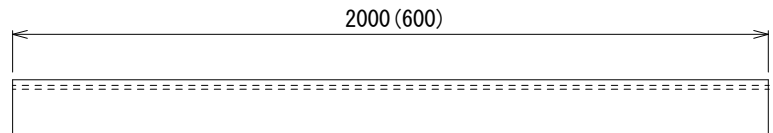
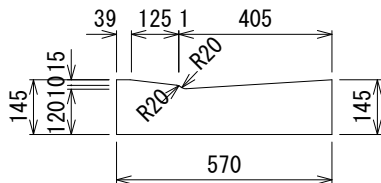

切り下げ型R(ハリアリ型)

MD-AF25型 121kg

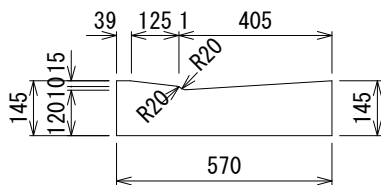

縁塊切り下げ型(ハリアリ型)

MD-AF25型 97kg

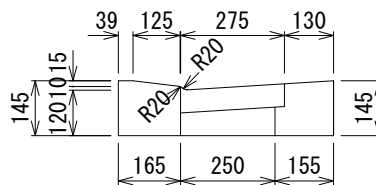

グレーチング

普通目 T-25 9.8kg

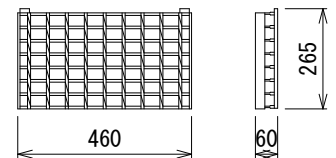

細目スバリ止め グレーチング T-25 14.1kg

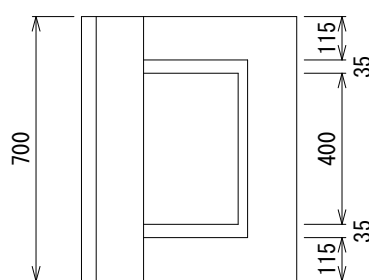
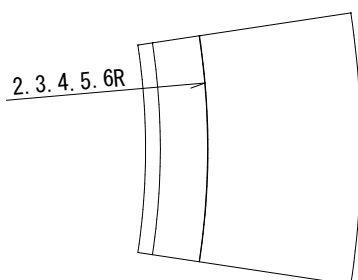
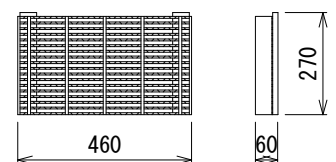

千葉土木型 L 形 (L=2000)

I 型

標準型 476kg

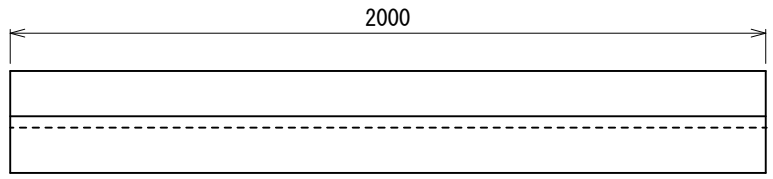
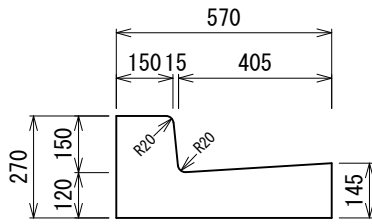

切り下げ型

MD-A20型 376kg

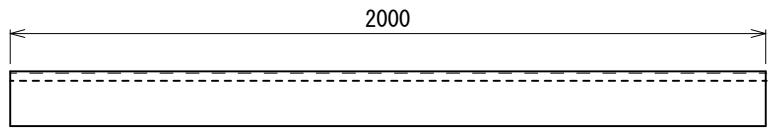
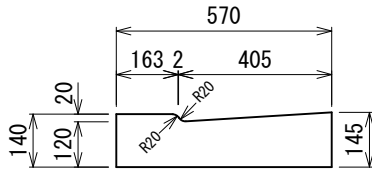

MD-A50型 400kg

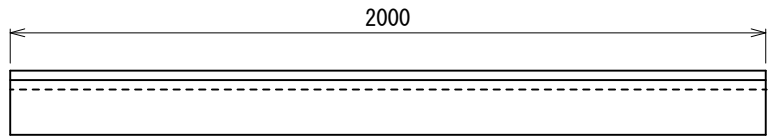
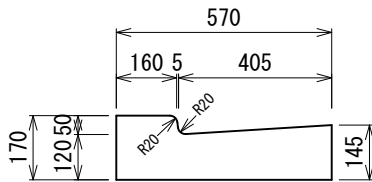

MD-A1型 391kg

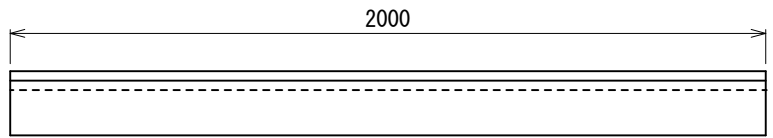
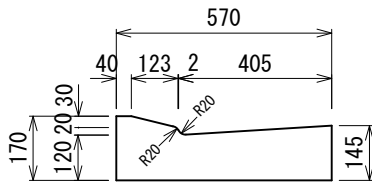

MD-A2型 446kg

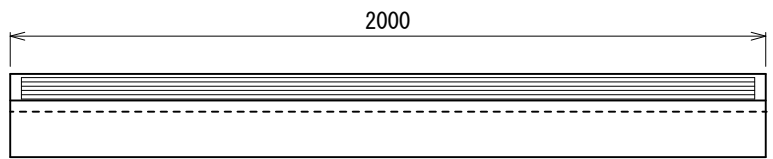
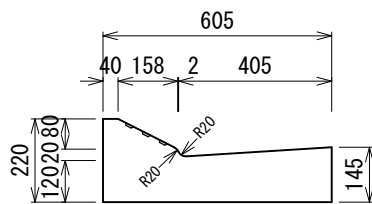

工場の表面突起模様も製造可
(スベリ止加工)

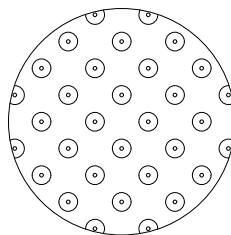

千葉土木型 L 形 (L=2000)

II 型

標準型

542kg

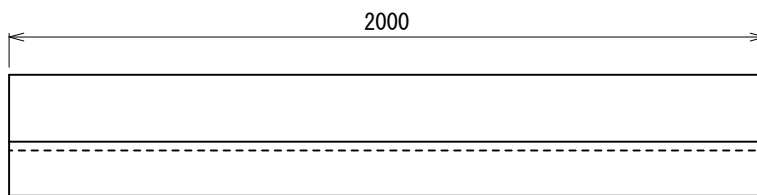
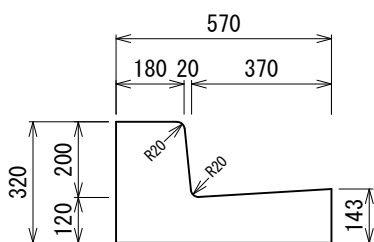

切り下げ型

MD-B20型 376kg

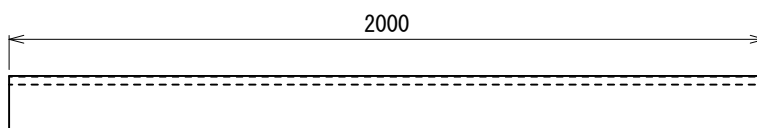
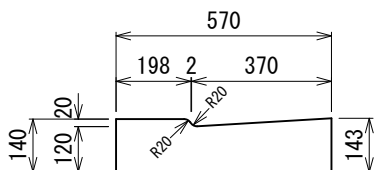

MD-B50型 404kg

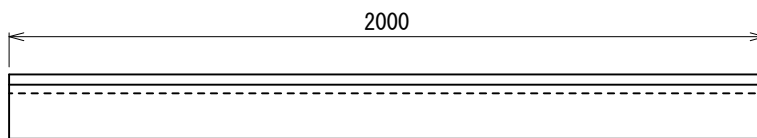
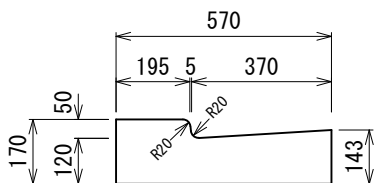

MD-B1型 394kg

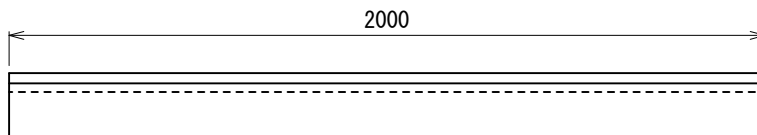
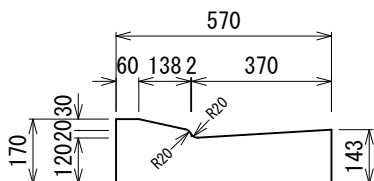

MD-B2型 422kg

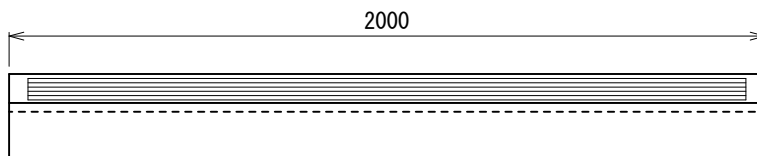
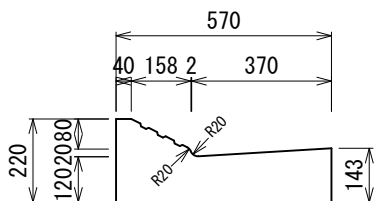

I¹°の表面突起模様も製造可
(スベリ止加工)

