

# L形側溝 (JIS A 5372 附属書5 推奨仕様5-4)

## L形側溝

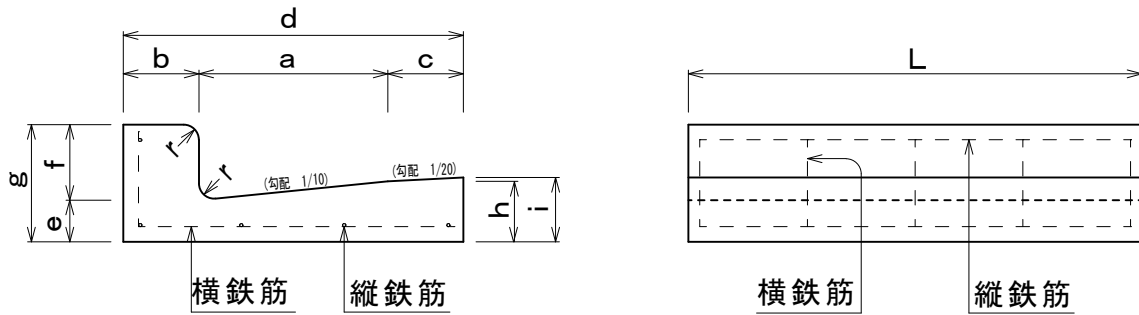

## すりつけ型 (斜)

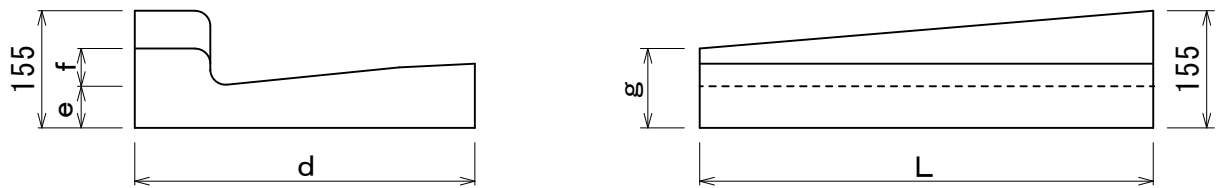

## 切り下げ型 (平)

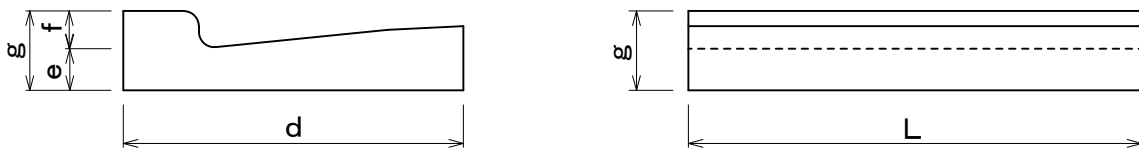

寸法及び配筋表

呼び (種類)	寸法 (mm)											配筋				重量 (kg)
	a	b	c	d	e	f	g	h	i	r	L	横鉄筋		縦鉄筋		
												径 (mm)	本数	径 (mm)	本数	
250A	250	100	-	350	55	100	155	80	-	20	600	4	5	4	4	4.7
250A斜 (MT-20)	250	100	-	350	55	20	75	80	-	20	600	4	5	4	4	4.1
250A平 (MD-20)	250	100	-	350	55	20	75	80	-	20	600	4	5	4	4	3.5
250A斜 (MT-50)	250	100	-	350	55	50	105	80	-	20	600	4	5	4	4	4.3
250A平 (MD-50)	250	100	-	350	55	50	105	80	-	20	600	4	5	4	4	4.0
250B	250	100	100	450	55	100	155	80	85	20	600	4	5	4	5	5.9
250B斜 (MT-20)	250	100	100	450	55	20	75	80	85	20	600	4	5	4	5	5.3
250B平 (MD-20)	250	100	100	450	55	20	75	80	85	20	600	4	5	4	5	4.7
250B斜 (MT-50)	250	100	100	450	55	50	105	80	85	20	600	4	5	4	5	5.5
250B平 (MD-50)	250	100	100	450	55	50	105	80	85	20	600	4	5	4	5	5.2
300	300	100	100	500	55	100	155	85	90	20	600	4	6	4	5	6.5
300斜 (MT-20)	300	100	100	500	55	20	75	85	90	20	600	4	6	4	5	5.9
300平 (MD-20)	300	100	100	500	55	20	75	85	90	20	600	4	6	4	5	5.3
300斜 (MT-50)	300	100	100	500	55	50	105	85	90	20	600	4	6	4	5	6.1
300平 (MD-50)	300	100	100	500	55	50	105	85	90	20	600	4	6	4	5	5.8
350	350	100	100	550	55	100	155	90	95	20	600	6	5	4	5	7.2

# L形側溝(乗入れ用)すりつけ型(斜)及び切り下げ型(平)

## 標準型

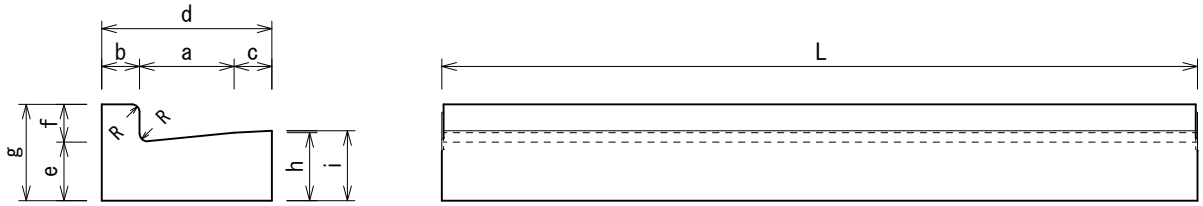

## すりつけ型

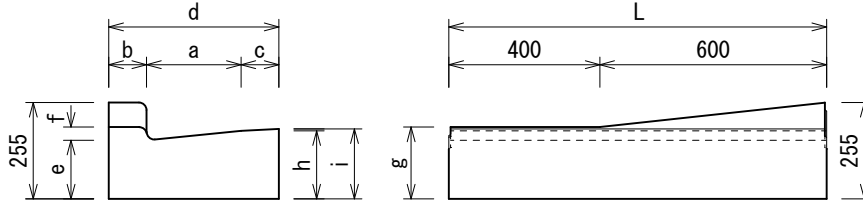

## 切り下げ型

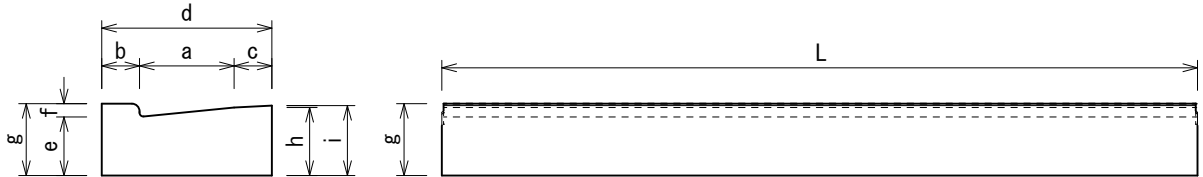

## 縁塊

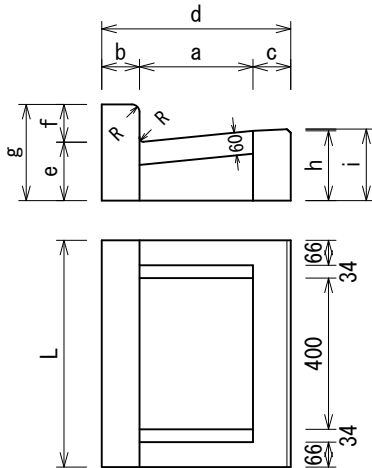

## グレーチング

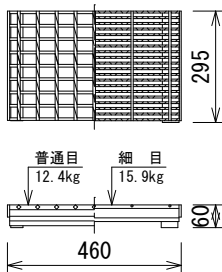

## 寸法表

呼 び (種類)	寸 法 (mm)											重量 (kg)	
	a	b	c	d	e	f	g	h	i	r	L		
L 形	TRC 2 5 0 A	250	100	-	350	155	100	255	180	-	20	2000	330
	TRC250A斜(MT-20)	250	100	-	350	155	20	175	180	-	20	1000	149
	TRC250A平(MD-20)	250	100	-	350	155	20	175	180	-	20	2000	291
	TRC250A斜(MT-50)	250	100	-	350	155	50	205	180	-	20	1000	159
	TRC250A平(MD-50)	250	100	-	350	155	50	205	180	-	20	2000	305
	TRC 2 5 0 B	250	100	100	450	155	100	255	180	185	20	2000	420
	TRC250B斜(MT-20)	250	100	100	450	155	20	175	180	185	20	1000	194
	TRC250B平(MD-20)	250	100	100	450	155	20	175	180	185	20	2000	381
	TRC250B斜(MT-35)	250	100	100	450	155	35	190	180	185	20	1000	199
	TRC250B平(MD-35)	250	100	100	450	155	35	190	180	185	20	2000	388
TRC250B斜(MT-50)	250	100	100	450	155	50	205	180	185	20	1000	204	
TRC250B平(MD-50)	250	100	100	450	155	50	205	180	185	20	2000	395	
TRC 3 0 0	300	100	100	500	165	100	265	195	200	20	2000	491	
TRC300斜(MT-20)	300	100	100	500	165	20	185	195	200	20	1000	230	
TRC300平(MD-20)	300	100	100	500	165	20	185	195	200	20	2000	452	
TRC300斜(MT-50)	300	100	100	500	165	50	215	195	200	20	1000	240	
TRC300平(MD-50)	300	100	100	500	165	50	215	195	200	20	2000	466	
縁 塊	TRC300標準型	300	100	100	500	155	100	255	185	190	20	600	86
	TRC300平(MD-20)	300	100	100	500	155	20	175	185	190	20	600	74
	TRC300平(MD-35)	300	100	100	500	155	35	190	185	190	20	600	76
	TRC300平(MD-50)	300	100	100	500	155	50	205	185	190	20	600	78

\* 縁塊のe, g, h, i寸法、+10の製品製造できます。

## 敷設図

